

StudioComm for Surround

Model 76B Central Controller and Model 77B Control Console

User Guide

Issue 2, July 2009

**This User Guide is applicable for systems consisting of:
Model 76B: serial number M76B-00151 and later with software version 1.05;
Model 77B: M77B-00151 and later with software version 2.00 and later**

© 2009 by Studio Technologies, Inc., all rights reserved
www.studio-tech.com

This page intentionally left blank.

Table of Contents

Introduction.....	5
Installation	8
Advanced Installation	14
Configuration	15
Operation.....	31
Technical Notes	38
Specifications	40
Appendix A—Connection Pin Out Charts.....	42
Block Diagrams	
Model 76B Central Controller	
Model 77B Control Console	

This page intentionally left blank.

Introduction

What This User Guide Covers

This User Guide is designed to assist you when installing and using the Model 76B Central Controller and one or more associated Model 77B Control Consoles.

Overview

As creating and distributing multi-channel surround (5.1) and stereo (2-channel) audio material has become a day-to-day reality, the ability to simply and effectively monitor these sources is imperative for recording, post-production, and broadcast facilities. Studio Technologies has addressed these needs with the StudioComm for Surround Model 76B Central Controller and Model 77B Control Console. With its digital audio inputs, analog outputs, Dolby® E dialnorm support, and extensive set of user resources it's a simple task to integrate the system into virtually any facility. The carefully selected group of features, including flexible input source selection, dialnorm display, channel downmix, channel solo, and reference level, make the system powerful yet simple to operate. And by using the best of contemporary technology, as well as following rigorous design practices, the system's audio quality is excellent. With the StudioComm for Surround system any audio console, disk-based recording system, or broadcast facility can have a complete multi-channel monitor system. Its unique feature set makes it especially well suited to meet the unique needs of broadcast master control applications.

A StudioComm for Surround system starts with the Model 76B Central Controller. It occupies one space in a standard 19-inch rack. Two surround (5.1) and three

stereo (2-channel) audio inputs, along with a surround (5.1) and an auxiliary stereo (2-channel) monitor outputs, are provided. The surround and stereo inputs are digital and compatible with AES3id sources. These unbalanced digital signals utilize BNC connectors and are ubiquitous in most post-production and broadcast environments. Sample rates of up to 192 kHz and bit depth of up to 24 are directly supported. With the system's dynamic range of greater than 106 dB, there isn't a problem ensuring that a source's audio quality is maintained. The monitor outputs are analog, balanced line-level, with a maximum signal level of +26 dBu. They include power-up/power-down protection circuitry to help maintain the health of the connected loudspeaker systems.

A source of Dolby E metadata can be connected to the Model 76B Central Controller. This RS-485/RS-422 115.2 kbit/s serial data signal carries numerous data elements, including one that represents the average dialog level of an associated audio program. This dialog normalization or "dialnorm" value is an integral part of many broadcast distribution systems, ending up as part of consumer audio playback systems. Hardware and software within the Model 76B separates the dialnorm element that relates to one of the connected surround audio sources. This dialnorm level value can be displayed on the Model 77B Control Console, as well as being used to automatically adjust the surround monitor output level. This provides a unique solution to the broadcast and post-production world, allowing a professional environment to accurately simulate an end user's experience.

Digital audio signals are interfaced with the Model 76B using nine BNC connectors. Analog monitor output signal connections

are made using one 25-pin D-subminiature connector. An advanced flash-based microcontroller integrated circuit provides the logic “horsepower” for the unit. AC mains power is connected directly to the Model 76B, which is factory selected for 100, 120, or 220/240 V operation. The internal power supply utilizes two toroidal mains transformers for quiet audio operation. One 9-pin D-subminiature connector is used to connect the Model 76B with up to four Model 77B Control Consoles. A second 9-pin “D-sub” connector is used to interface the Dolby E dialnorm data and remote control signals with the Model 76B.

The Model 77B Control Console is the “command center” and is designed to reside at an operator’s location. It allows fingertip selection of all monitoring functions. Numerous LED indicators provide complete status information. A 4-digit numeric display indicates the monitor output or dialnorm level in real time. A major

strength of the Model 77B is its ability to configure, under software control, many important operating parameters.

While most installations will use only one Model 77B Control Console, up to four can be connected to a Model 76B Central Controller. This provides multiple users with full control over a facilities’ monitor system. The Model 76B can provide power for the first two Model 77B units while an external 12 volt DC source is required for a third and fourth unit. The interconnecting cables use 9-pin D-subminiature connectors to carry RS-485 data and DC power.

Additional Details

The Model 77B provides four buttons and associated LEDs for selecting the input source to be monitored. The buttons are designed such that up to six unique input choices are available. Using the Model 77B’s configuration mode, each of the six input choices can be configured from the

Figure 1. Model 76B Central Controller Front Panel

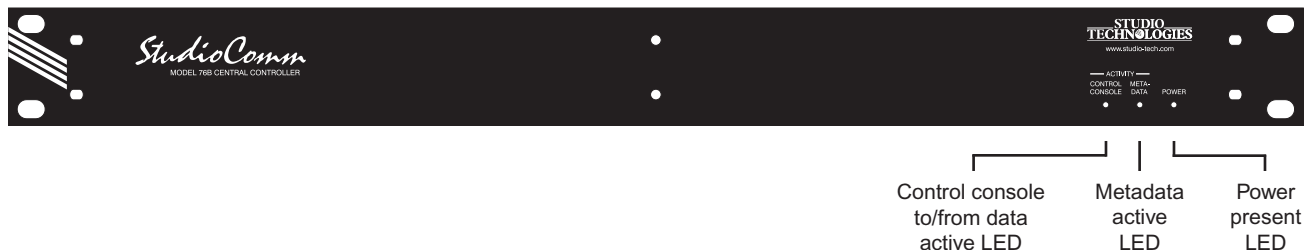
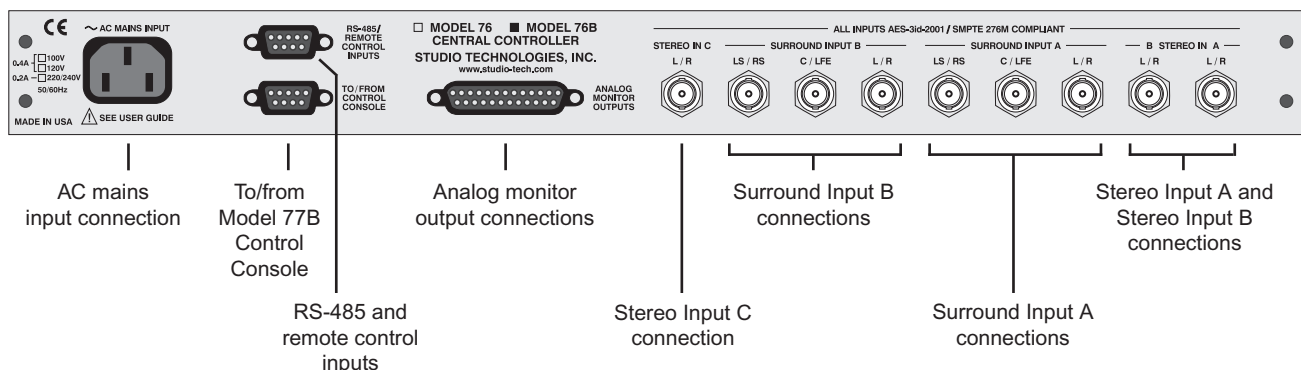

Figure 2. Model 76B Central Controller Back Panel



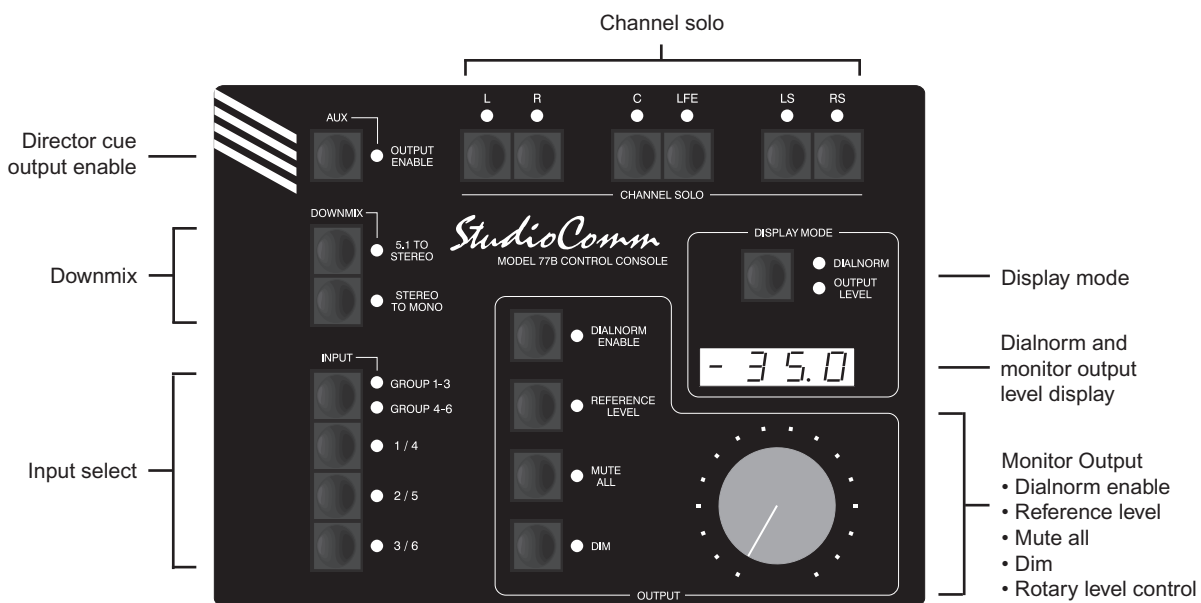

Figure 3. Model 77B Control Console Front Panel

system's two surround (5.1) and three stereo (2-channel) inputs. The configuration mode also allows stereo inputs A and B to be used as either stereo or monaural sources. This is especially useful in broadcast applications where a 2-channel AES3id source may carry two independent monaural signals. To highlight this powerful feature: the Model 77B allows independent monitoring of the two channels associated with a single AES3id source. Broadcast master control applications can greatly benefit from this configuration flexibility.

The surround monitor output level can be controlled by way of a large, easy-to-use rotary control. The control, actually a digital encoder, allows level selection in precise 0.5-dB steps. The auto mute all function causes the monitor output channels to automatically mute whenever the output level is set to its minimum position. Using the reference level function, the monitor output level can be set to a pre-configured value. This is provided for audio-with-picture applications that require a specific

monitor output level. The reference level is easily configured by taking an electronic "snapshot" of the desired monitor output level. For operator confirmation a 4-digit LED readout can display the level of the surround monitor output channels. To match the needs of a facility, it can be configured to display either the attenuation level or the sound pressure level (SPL).

The dim function allows the surround monitor output level to be reduced by a fixed dB amount. The dim level is configured from among four available values. A mute all function allows all surround monitor output channels to be simultaneously muted. The channel solo section provides individual surround channel monitoring control, allowing a single channel to be monitored while the others are automatically muted. Multiple channels can also be simultaneously selected for "soloing."

A special solo mode is also provided, called channel pop solo, which offers a unique aid in monitoring audio material.

Channel pop solo allows the level of a single channel to be raised while the level of the other channel is reduced. This helps to emphasize the content on one channel without fully muting the others. Broadcast applications can benefit from the channel pop solo mode, allowing, for example, the center channel to be highlighted while still maintaining some level on the other channels. The amount of level increase—the “pop”—as well as the amount of attenuation can be configured to meet the needs of specific applications or users.

Two functions allow the input sources to be checked for level or phase inconsistencies. The 5.1 to stereo downmix function is used to create a stereo signal from the selected surround (5.1) source. The stereo to mono downmix function allows audio on the left and right channels to be added (summed) and monitored on the center output channel. The two downmix functions can be simultaneously enabled, allowing a surround source to be checked for mono compatibility.

In addition to the surround (5.1) monitor output, a stereo (2-channel) auxiliary monitor output is also provided. A stereo signal, connected to stereo input C on the Model 76B Central Controller, can be routed to the auxiliary monitor output. A pushbutton on the Model 77B Control Console allows on/off control of the signal; no level control or signal modification takes place. The auxiliary monitor output feature can be useful in special applications, e.g., in a broadcast control room setting where an audio signal, such as site-event cue signals, needs to be monitored by way of an independent set of loudspeakers.

For flexibility, the StudioComm for Surround system is designed to easily integrate with equipment such as production intercom systems, on-air or recording tally signals, audio consoles, and film motion-control electronics. Three remote-control input functions are provided: mute all, dim, and auxiliary monitor output on/off. By providing access to these functions, talkback or slate activity from an audio console or other communications system can control the level of the surround monitor output or enable to the auxiliary monitor output.

Installation

In this section you will be installing the Model 76B Central Controller in an equipment rack. Connections to the digital audio inputs and analog monitor outputs will be made. If desired, a source of Dolby E metadata will be connected and external equipment will be interfaced to the remote control inputs. A location will be selected for the first Model 77B Control Console and it will be connected to the Model 76B. AC mains power will be connected to the Model 76B.

For advanced applications up to three additional Model 77B Control Console units can be connected to the Model 76B. Please refer to the Advanced Installation section of this guide for details.

System Components

The main shipping carton contains one each of the following: Model 76B Central Controller, Model 77B Control Console, 9-pin D-sub interconnecting cable, and user guide. Units destined for North America also include an AC mains cord. Your dealer or distributor should provide an

AC mains cord for destinations outside of North America. Any additional Model 77B Control Consoles will be shipped in separate cartons.

Mounting the Model 76B

The Model 76B Central Controller requires one space in a standard 19-inch (48.3 cm) equipment rack. Select a location that is convenient for making connections to the digital and analog audio signals as well as interfacing with the Model 77B Control Console. A cable is supplied to connect the Model 76B to the Model 77B. If the needs of a specific installation dictate, an alternate-length interconnecting cable can be fabricated and used. Secure the Model 76B into the equipment rack using two mounting screws per side.

Audio Connections

Audio signal connections are made by way of nine BNC jacks and one 25-pin D-subminiature connector which are located on the Model 76B's back panel. Refer to Figure 2 for a detailed view of the back panel. The BNC jacks will be used for interconnecting with the digital audio signals. A cable assembly with a 25-pin D-sub plug (male) on one end and the desired connectors on the other end will be used for connecting to the analog monitor outputs.

Digital Audio Inputs

Prior to sources being connected to the five inputs it's worth reviewing how they are used by the StudioComm system. Surround inputs A and B each have six channels (5.1) and can be configured for monitoring over the surround monitor output channels. The relationship between input channels and output channels is maintained, i.e., left input to left monitor

output, right input to right monitor output, center input to center monitor output, etc. (Of course this won't be true in the special case where the 5.1 to stereo downmix function is enabled.)

Stereo inputs A and B can be configured to be used as a stereo source or as two independent monaural sources. When configured as a stereo source the left channel is routed to the left monitor output and the right channel to the right monitor output. Alternately, the left and right input channels can be independently configured to output by way of the monitor output's center channel. In this way a single digital audio source can supply one or two monaural signals to the StudioComm system and be correctly monitored.

Stereo input C is unique in that it can serve as a source for both the surround and the auxiliary monitor outputs. As with the other inputs, stereo input C can be assigned, using the configuration function, to an input select button. This will allow stereo input C to be monitored using the left and right channels of the surround monitor output. In addition, the signal connected to stereo input C will be routed to the auxiliary monitor output whenever that function is active. To clarify: if the auxiliary monitor output is enabled (turned on) a signal on the left channel of stereo input C will be present on the left channel of the auxiliary monitor output; a signal on the right channel of stereo input C will be present on the auxiliary monitor output's right channel.

It's important to note that there is one limitation regarding stereo input C. Unlike stereo inputs A and B, it can only be used as a stereo (2-channel) source. Its left and right channels can't be independently monitored over the center channel

of the surround monitor output. (The configuration function doesn't allow this anyway so there is no potential for a problem to develop.) Also, the left and right channels of stereo input C can't be independently monitored by way of the auxiliary monitor output. It follows a left-in-to-left-out, right-in-to-right-out scheme.

The nine female BNC connectors on the Model 76B's back panel are used to interface with digital audio signal sources. Each of the digital audio inputs is intended for connection to an unbalanced digital audio source that is compatible with the AES3id-2001 standard. In broadcast environments these signals may also be referred to as following the SMPTE 276BM standard. As expected, these signal sources will be provided in the form of coaxial cables with BNC plugs attached. The Model 76B supports sampling rates of up to 192 kHz with a word length (depth) of up to 24 bits. Note that no master external synchronization source is required as each input is independently self-clocking.

Balanced AES3 digital audio signals can also be used with the Model 76B's inputs if external coupling transformers ("baluns") are utilized. These impedance-matching (110 ohms to 75 ohms) transformer assemblies typically provide a 3-pin female XLR connector on their input and a female BNC connector on their output.

Analog Monitor Outputs

The connector labeled Analog Monitor Outputs provides access to the Model 76B's surround (5.1) and stereo (2-channel) auxiliary monitor outputs. The surround output channels are intended to connect to the main loudspeaker system incorporated in a facility. The auxiliary monitor

output channels are provided to support a separate set of loudspeakers, the primary application intended to allow monitoring of inter- or intra-facility communications.

The monitor output channels are designed for connection to audio amplifiers associated with monitor loudspeakers, or to the inputs of loudspeakers that contain integrated amplifiers. The monitor outputs are electronically balanced and capable of driving balanced or unbalanced loads of 600 ohms or greater. While balanced operation is preferred, unbalanced operation does not pose a problem. To connect to an unbalanced load connect the + terminal as signal high, and both the – and shield as the signal low/shield. For optimal unbalanced operation, it is important to connect both – and shield together directly on the D-sub plug, not at the other end of the harness.

Note that while the Model 76B's electronically balanced output circuits are capable of driving loads of 600 ohms or greater their output level will drop slightly as the load impedance approaches 600 ohms. A 0.5 dB difference in output level can be expected as the load impedance changes from 10 k ohms to 600 ohms.

The wiring scheme used by the D-sub-miniature connector complies with that made popular by TASCAM® with their DA-88® product. A wiring assembly prepared for the Model 76B's monitor outputs is identical to that of a DA-88-style output assembly. Please refer to Figure 4 for the exact connection details. Note that unlike a DA-88-style assembly, the two threaded fasteners associated with the Model 76B's D-sub connector uses 4-40 threads. This complies with the original design standard for D-subminiature connectors.

Connections	Signal High (+)	Signal Low (-)	Shield
L	24	12	25
R	10	23	11
C	21	9	22
LFE	7	20	8
LS	18	6	19
RS	4	17	5
Auxiliary L	15	3	16
Auxiliary R	1	14	2

Notes: 1) All signals transformer-coupled digital audio; selectable for AES3 or AES3id compatibility.

2) Connector type on Model 76B is 25-pin D-subminiature female (DB-25F). Installer must provide male (DB-25M). Connector uses 4-40 threaded inserts for locking with mating plug.

3) Wiring scheme follows TASCAM DA-88 convention. Standard DA-88-type wiring harnesses are directly compatible, with the exception of 4-40 screw threads being required.

Figure 4. Connections for Surround and Auxiliary Monitor Outputs

Metadata Input

The Model 76B allows a source of Dolby E metadata to be directly connected. Hardware and software inside the Model 76B extracts (“parses”) one of the dialnorm data elements from the connected metadata signal. This dialnorm value can be viewed on the Model 77B’s LED display and, if desired, used to control the monitor output levels. Refer to the Technical Notes section of this guide for details.

The metadata signal is connected by way of a 9-pin D-subminiature connector, labeled RS-485/Remote Control Inputs, which is located on the back panel of the Model 76B. Refer to Figure 5 for exact connection details. While only the data + and data – connections are absolutely necessary, a shield connection can also be made. Note that the connections for the metadata signal are reminiscent of the SMPTE 207M standard.

Signal	Pin	Direction
RS-485 Data +	7	Input
RS-485 Data –	2	Input
Data Shield	1	Shield
Remote Mute All	5	Input
Remote Dim	6	Input
Remote Aux Monitor Out On/Off	8	Input
Remote Spare	9	Input
Remote Input Common	4	Common

Note: Connector type on Model 76B is 9-pin D-subminiature female (DE-9F) Connector uses 4-40 threaded inserts for locking with mating plug.

Figure 5. Connector Pin Outs for Metadata and Remote Control Inputs

The metadata signal must be in the form of RS-485 or RS-422 asynchronous serial data. This differential signal must have a data rate of 115.2 kbit/s and a data format of 8 data bits, no parity, and 1 stop bit (8-N-1). A metadata signal of this type is commonly available on metadata-generating or de-embedding equipment from broadcast equipment manufacturers such as Dolby Laboratories®, Evertz®, and NVISION®.

While in hardware the Model 76B’s RS-485 input connection is bi-directional, in software it’s configured only to receive data. This means that there’s no reason why a signal already connected between two other pieces of equipment can’t also be connected in parallel (“bridged”) with the Model 76B’s metadata input.

A word of advice—Studio Technologies has found documentation supplied with some metadata-generating equipment has incorrect (or at least confusing) pin-out information. This has resulted in much head scratching and hair pulling. As such, it may be valuable to use a logic analyzer

or oscilloscope to confirm that the metadata source is actually on the expected pins of the source connector prior to connecting it to the Model 76B.

Remote Control Inputs

Support is provided for three remote control input functions: remote mute all, remote dim, and remote auxiliary monitor output on/off. The inputs use logic gates, “pulled up” to +5 volts DC by way of resistors, which are active whenever they are brought to their logic low state. Inputs of this type are commonly referred to as GPI inputs. While the input circuitry is protected from over-current and static (ESD) discharge, care should be taken to prevent nasty signals from reaching them. The inputs are active only when held in the low state; they can’t be configured to change state (“latch”) in response to a logic pulse.

The same 9-pin D-subminiature connector used for the metadata input is also used for the remote control inputs. Refer to Figure 5 for the exact connection details. Note that pin 4 (remote input common) connects to the Model 76B’s internal circuit common connection as well as the Model 76B’s chassis and mains earth connections. Figure 5 also shows one spare remote control input (pin 9). This is provided for future applications and should remain unconnected.

Connecting the Model 76B to the Model 77B

A 9-pin female D-subminiature connector, labeled To/From Control Console, is provided on the back panel of the Model 76B Central Controller. This is used to interface the unit with Model 77B Control Consoles. A 9-pin female D-sub connector, labeled

To/From Central Controller, is provided on the back panel of each Model 77B Control Console. A cable with 9-pin male D-sub connectors on each end is used to interconnect the Model 76B with the Model 77B units. A cable is included in the shipping carton. The cable implements all nine connector pins in a one-to-one manner.

Should an interconnecting cable of a different length be required there’s no problem for one to be fabricated and used. While it can be wired in a one-to-one fashion covering all nine pins, a minimum of only four connections are required: pin 1 (data +), in 6 (data –), pin 4 (DC +), and pin 9 (DC –). The Model 76B’s connector pin-out scheme was designed to allow creation of an interconnecting cable which uses commonly available 2-pair audio cable. This cable, consisting of two twisted pairs each with an individual shield, is typically sleek, flexible, and available in many colors. One pair and shield can be used for the data connections while the other pair and shield can be used for the DC connections. This implementation has the advantages of providing a shield for the data path and a more robust common connection (two conductors including the shield) for the DC power circuit. Refer to Figure 6 for details.

A few simple calculations are required to determine the maximum cable length when connecting a Model 77B to a Model 76B. The differential transmission scheme used by the system’s RS-485 interface makes an interconnection in excess of 1000 feet (300+ meters) easily possible. The limiting factor is typically the ability of the wiring to pass the DC power supplied by the Model 76B to the Model 77B. The Model 76B supplies 12 volt DC nominal with a maximum current of 200 milliamperes.

Signal	Pin	Direction
Data +	1	To/From Model 77B
Data –	6	To/From Model 77B
Data Shield	2	To/From Model 77B
DC +	4	To Model 77B
DC –	9	To Model 77B
DC Power Shield	5	To/From Model 77B

Note: Connector type on Model 76B is 9-pin D-subminiature female (DE-9F). Connector uses 4-40 threaded inserts for locking with mating plug.

Figure 6. Connections between Model 76B and Model 77B

The Model 77B requires a minimum of 9 volts DC, 100 milliamperes maximum for correct operation. (The voltage must be measured directly at the Model 77B's 9-pin connector.) So the maximum interconnecting cable length is directly related to the resistive voltage losses associated with the two DC-carrying conductors. As the Model 76B supplies 12 volts and the Model 77B requires 9 volts minimum, this directly leads to a 3 volt DC maximum drop due to the interconnecting cable. Using Ohm's law it's quite easy to determine whether the selected cable will support the desired interconnection length. Calculate the voltage drop by multiplying the total resistance (in ohms) of the proposed cable by 0.01 (the square of the Model 77B's maximum required current). Remember to include the resistance in both the DC + and DC – wires in the figure for the total resistance.

AC Mains Power

The Model 76B is internally configured to operate from nominal 100, 120, or 220/240 volts, 50/60 Hz. Units shipped to North America are factory selected for 120 volt operation. Units bound for Japan are generally selected for 100 volts while our friends

“down under” and in Europe receive units set for 220/240 volts. Before connecting the Model 76B to AC mains power, check to be certain that it is configured to match the local mains voltage. Look on the back panel (adjacent to the power entry connector) for an indication of the factory-configured voltage. Note that an incorrect configuration could prevent operation or cause damage to the unit. Should it be necessary to change the unit's operating voltage it must be performed only at the factory, or by a factory-authorized service technician.

The Model 76B uses an IEC-standard C14 inlet connector to mate with the AC mains cord. The AC mains cord should have a C13 socket affixed with the wire colors conforming to the internationally recognized CEE color code:

<u>Connection</u>	<u>Wire Color</u>
Neutral (N)	Light Blue
Line (L)	Brown
Protective Earth (E)	Green/Yellow

Safety Warning: The Model 76B does not contain an AC mains disconnect switch. As such, the AC mains cord plug serves as the disconnection device. Safety considerations require that the plug and associated outlet be easily accessible to allow rapid disconnection of AC mains power should it prove necessary.

As soon as AC mains power is applied, the Model 76B Central Controller's power LED will light steadily. The two data activity LEDs, control console and metadata, may also light. Each of the connected Model 77B Control Consoles will go through a power-up sequence, lighting each LED in

succession. Using its 4-digit display, each Model 77B will also momentarily display its address, its software version, and the software version of the associated Model 76B.

Advanced Installation

Additional Model 77B Control Consoles

Some installations will benefit from the Model 76B's ability to be controlled by up to four Model 77B Control Consoles. In this section details on how to connect additional Model 77B units will be reviewed. While control of one Model 76B by up to four Model 77B units is fully supported, one limitation does exist. A Model 76B Central Controller is capable of providing DC power for only one or two Model 77B units. Connecting a third or fourth Model 77B requires use of a separate source of 12 volt DC power. As each Model 77B unit requires a maximum current of only 100 milliamperes, obtaining an external power supply should not prove to be an issue. Many low-cost external 12 volt DC power supplies are available that will be suitable to the task. For optimal operation they should be a "switch-mode" type with a filtered and regulated output.

As covered in a previous section of this user guide, a 9-pin female D-subminiature connector, labeled To/From Control Console, is provided on the back panel of the Model 76B Central Controller. This is provided to interface the Model 76B with up to four Model 77B Control Consoles. A 9-pin D-sub connector, labeled To/From

Central Controller, is provided on the back panel of each Model 77B Control Console. A cable with 9-pin male D-sub connectors on each end is used to interconnect each Model 77B with the Model 76B. A cable is included in the main shipping carton as well as with each "solo" Model 77B. These cables implement all nine connector pins in a one-to-one manner.

When connecting one or two Model 77B units to a Model 76B all nine pins of the interconnecting cables can be connected in parallel ("multed"). This will connect the data signals between all the units and route the Model 76B's 12 volt DC power output to both Model 77B units. A basic cable implementation would have pin 1 (data +), pin 6 (data -), pin 4 (DC +), and pin 9 (DC -) connected. Connecting to a third and fourth Model 77B requires that only pin 1 (data +) and pin 6 (data -) be connected from the Model 76B to the third and fourth Model 77B units. (This will create a "data bus" between the Model 76B and all of the Model 77B Control Consoles.) An external 12 volt DC source must provide power to the third and fourth Model 77B. This power source, capable of supplying a minimum of 200 milliamperes of current (100 milliamperes per Model 77B), needs to connect to pin 4 (DC +) and pin 9 (DC -) on the third and fourth unit.

Previous paragraphs of this user guide discussed the Model 76B to Model 77B cable length issues. Please review that information prior to creating the interconnection scheme to be used for installing multiple Model 77B units.

Configuration

After the physical installation has been completed it's important that the system's configuration options be carefully reviewed. In most cases one or more of the operating parameters will need to be revised to meet the needs of a specific installation. Many of the parameters will impact the signal flow in to and out of the Model 76B Central Controller. Other parameters affect how the one or more Model 77B Control Consoles will display status conditions and respond to user commands.

Configurable Parameters

Many StudioComm functions can be configured to meet the exact needs of an installation. The Model 77B Control Console is used to display and select the desired system configuration. Here's an overview of what can be configured:

- Model 77B Device Address
- Auxiliary Monitor Output Nominal Level
- Digital Input Reference Level
- Monitor Output Nominal Level
- Input Select Buttons
- Reference Level
- Overall Display Mode
- Reference Level in dB SPL
- Dialnorm Reference Level
- Dialnorm Data to Surround Input Assignment
- Dim Level
- Remote Inputs
- Channel Pop Solo Mode Offset Levels

The configuration diagrams, located at the end of this section, give details on setting each parameter. An overview of each configurable parameter is provided in the following paragraphs.

Entering and Exiting the Configuration Mode

A small button is located on the back of each Model 77B Control Console, adjacent to the 9-pin D-sub connector. On any connected Model 77B pressing and holding this button for two seconds places both the Model 76B and all the connected Model 77B units into the configuration mode. The Model 76B will immediately mute the monitor outputs as a protection measure. In the configuration mode the Model 77B's array of buttons and LEDs no longer perform their normal functions, instead allowing you to observe and change many of the operating parameters. The dialnorm and output level LEDs, associated with the display mode section, will light alternately to indicate that the configuration mode is active.

To leave the configuration mode and return the Model 77B units to normal operation once again press and hold the configure button for two seconds. Note that configuration changes are stored in nonvolatile memory only after the configuration mode has been exited.

Our apologies to those of you who find the configure button a pain to use, but it's supposed to be that way! Seriously, the top of the button is slightly recessed from the back panel, making it harder to accidentally activate. We didn't want normal operation to cease because someone pushed a Model 77B into a "rats nest" of schedules, memos from management, and empty

coffee cups! But a firm press with the fleshy part of an index finger should do the trick.

There is no problem frequently “tweaking” the system’s operating parameters to achieve the desired performance. The configuration data is stored in nonvolatile memory, which is rated for thousands of read and write cycles and a retention time in tens of years. Note that memory integrated circuits are located in both the Model 76B Central Controller and the Model 77B Control Consoles. Only the individual device address is stored in each Model 77B. All other configuration parameters are stored in the Model 76B.

Model 77B Device Address

A unique device address must be assigned to each Model 77B that is connected to a Model 76B. The choices are A1, A2, A3, or A4, with the default address being A1. As most installations will find only one Model 77B utilized, its default setting is appropriate. For installations that use a second, third, or fourth Model 77B each unit must be configured with a unique device address. Problems will occur if more than one unit has the same address! It’s important to highlight the fact that the device address is the only setting that must be done on each individual Model 77B unit. All other settings can be made on any one of the connected Model 77B units.

Auxiliary Monitor Output Nominal Level

The nominal level of the stereo (2-channel) auxiliary monitor output can be configured to match the requirements of a specific installation. Devices connected to the auxiliary monitor output could include an amplifier associated with a loudspeaker system or

inputs on self-contained amplified loudspeakers. (These types of devices must include a means of adjusting their output level.) This configuration setting defines the analog output level when a digital input source, at its reference level, is connected and the auxiliary monitor output is enabled. The choices are +4.0, 0.0, –6.0, or –12 dBu. When connecting to the input of a device that’s not associated with a loudspeaker system most applications will find the +4.0 dBu setting correct as it meets the dominant worldwide audio standards. For broadcast applications that follow the PAL standards the 0.0 dBu setting may be appropriate. Devices such as amplified speakers will often perform better when receiving signals with a lower nominal level. In the latter case the ability to comfortably use a level potentiometer may be greatly enhanced using the –6.0 or –12.0 dBu settings. The latter setting would be appropriate when connecting the auxiliary monitor output to the popular series of amplified loudspeakers from Fostex®.

While sometimes not fully understood, using the term dBu is more in line with contemporary audio applications than the outdated dBm and the “semi-pro” dBV references; dBu refers to audio levels without regard to their load impedance, typical of situations where an output has a low source impedance and is connected to a high-impedance input. An analog audio signal with a level of +4 dBu has an RMS level of 1.228 volts. A 0 dBu signal has an RMS level of 0.775 volts.

Digital Input Reference Level

Configuring the digital input reference level to match the sources associated with a specific installation is an important step toward achieving optimal audio performance. This ensures that the Model 76B’s digital

audio receiver integrated circuits are configured to match the digital input source's "0 VU" or average point. The digital input reference level can be selected from four choices: -20.0, -18.0, -16.0, and -14.0 dBFS. Note that this parameter sets, as a group, the input reference level for all of the Model 76B's digital input connections. The Society of Motion Picture and Television Engineers (SMPTE) recommends a reference level of -20 dBFS, a value which is also extensively used in professional audio applications. The recommended digital reference level for PAL broadcast applications is -18 dBFS. The other two levels were included because... well, we can't remember why! But it seemed like a good idea at the time. If you end up using the -16.0 or -14.0 dBFS settings please let us know why and we'll add that information to the next version of this user guide!

Monitor Output Nominal Level

The nominal level of the six channels associated with the surround (5.1) output are configured, as a group, to match the requirements of an installation. This setting defines the analog output level when a digital input source, at its reference level, is connected and the monitor output level is at its maximum. The choices are 0.0 or +4.0 dBu. Most applications will find the +4.0 dBu setting correct as it meets the dominant worldwide audio standards. For broadcast applications that follow the PAL standards the 0.0 dBu setting may be appropriate.

A final review of the two previously selected settings might now be in order. The most common input and output combination will have a digital input reference level of -20.0 dBFS and a monitor output nominal level of +4.0 dBu. For PAL broadcast

applications a setting of -18.0 dBFS for the digital input and 0.0 dBu for the analog outputs would be typical.

Input Select Buttons

The three input select buttons, along with the group select button, allow six source configurations to be selected for monitoring. The Model 76B has connections for two surround (5.1) and three stereo (2-channel) AES3id digital audio sources. Any of these sources can be assigned to any of the input select buttons. To fit broadcast applications where it's typical for non-stereo pairs to share an AES3id 2-channel path, the individual left and right audio channels of stereo inputs A and B can be assigned to separate input select buttons as required. These "mono" signals will be routed to the center monitor output channel.

Spending time reviewing the input select button configuration function may prove very worthwhile. It is a unique feature of the StudioComm for Surround system and offers a great opportunity to optimize monitoring performance.

Reference Level

For audio-with-picture applications it's often beneficial for monitoring to be done in reference to a known loudspeaker level. This is often referred to as "mixing to 85 dB" on the monitors. The StudioComm for Surround system allows a precise monitor output level to be stored, and then enabled by pressing the Model 77B button labeled Reference Level. Setting the reference level is very simple but care is required:

1. Set up a precision sound pressure level (SPL) measuring device at the desired listening location.

2. Place the StudioComm system in the normal operating mode, not the configuration mode. Be certain that the dim, mute all, reference level, dialnorm enable, and downmix functions are not active. The remote mute all or remote dim functions must not be active.
3. Use the Model 77B Control Console to select the input source that contains the desired reference signal source, e.g., pink noise.
4. Observing the SPL meter, adjust the Model 77B's rotary level control until the desired reference monitor system level has been reached.
5. Being careful not to disturb the position of the rotary level control, enter the configuration mode by pressing and holding the configuration button located on the Model 77B's back panel.
6. Once the configuration mode has been entered, the monitor outputs will mute. Press and hold the reference level button; its associated LED will begin to flash. After five seconds the LED will light steadily to indicate that a "snapshot" of the new reference level has been taken. The Model 77B's numeric display will then show the value of the new reference level. The value shown will always be a negative number as it's always a value less than the maximum output level. The reference level button can now be released.
7. To complete the process the configuration mode must be exited. This is performed by again pressing and holding the configure button for two seconds. The new reference level is now stored in the Model 76B's nonvolatile memory. Only by repeating the entire procedure can the value be changed.

Once the configuration mode has been exited, the monitor outputs will again become active. Confirm that the correct level has been stored by pressing the reference level button. The SPL meter should display the desired level. If not, repeat the calibration procedure to achieve the desired goal.

You might wonder why you have to press and hold the reference level button for five seconds before the selected value is recognized. This is provided specifically so that unauthorized users won't accidentally change the reference level while they experiment with the configuration mode. Only if you know the "secret" will you be able to store a new value.

Overall Display Mode

The Model 77B's 4-digit numeric display can be configured to display the output level in either an attenuation mode or an SPL mode. In the attenuation mode the output level is shown as a reduction in value relative to the maximum output level. When the rotary control is used to set the output level to its maximum the display will show 0.0. As the rotary control is moved in the counterclockwise direction the display will show negative values, reaching approximately -69.5 dB before the full mute function automatically mutes the outputs.

In the SPL mode the display can be configured to allow the output level to be presented to users in terms of the actual sound pressure level (SPL). Used in conjunction with the reference level in dB SPL configuration and the stored reference level, SPL mode allows a user to see a visual representation of the SPL level that is present in the listening environment. While it takes a little more care to correctly implement the SPL display mode, it can offer an enhanced experience for StudioComm users.

Reference Level in dB SPL

The reference level in dB SPL configuration allows a specific SPL value to be associated with the stored reference level value. In this way whenever the monitor output is at the reference level, either through activating the reference level function or manually adjusting the rotary level control, the Model 77B's display will show the configured SPL level. Whenever the monitor output is not at the reference value the display will show the current value, in dB, relative to the reference level. The reference level in dB SPL can be configured over a range of 70.0 to 100.0 dB in 1.0-dB steps. In many applications a value of 85 would be appropriate, reflecting the widely used audio-for-picture 85 dB monitoring reference level. (Typically this 85 dB is really 85 dBC, indicating that a C-weighting filter has been applied to the measurement.) Other common reference SPL values, such as 82 and 87, are well within the allowable range.

Dialnorm Reference Level

The dialnorm reference level parameter is provided so that the StudioComm system can be configured to match a facilities' or "plant" default dialnorm level. This value is used as a reference against which the surround monitor output level will, if enabled, be adjusted up or down in response to an incoming dialnorm value. The dialnorm reference level parameter can be adjusted over the entire -31 to -1 dB range but typical values will be in the range of -27 to -24 . Implementation purists might want to select -31 dB as it may well be the "truest" implementation of the dialnorm scheme. In this way the system will, when enabled, reduce the monitor output level whenever dialnorm is different than -31 dB. But as

bar fights have broken out over decisions such as this we'll leave the choice up to you! For additional information about dialnorm refer to the Technical Notes section of this user guide.

Dialnorm Data to Surround Input Assignment

For correct operation the connected Dolby E dialnorm data must be assigned to work in conjunction with its associated surround input. In this way the dialnorm data will only display, and level changes will only take place, when the appropriate surround input is selected by an operator.

Dim Level

The dim function is used to reduce the monitor output level by a preset amount. The reduction is in dB relative to the monitor output's current level. There are four dim level values available: -10.0 , -15.0 , -20.0 , and -25.0 dB.

Remote Mute All

Two configuration choices are associated with the remote mute all function: disabled and enabled. To utilize the remote mute all function simply requires you to select the enabled setting.

Remote Dim

Two configuration choices are associated with the remote dim function: disabled and enabled. To utilize the remote dim function simply configure it for enabled.

Remote Auxiliary Monitor Output On/Off

This function configures whether the on/off status of the auxiliary monitor output can be controlled using the remote control input.

Channel Pop Solo Mode Offset Levels

Two parameters can be configured that set how the channel pop solo function will impact audio levels. The up offset level sets the amount of increase (gain) that a channel will experience when it is soloed in the channel pop solo mode. The down offset level sets the amount of decrease (attenuation) that the non-soloed channels will experience when a channel is active in the channel pop solo mode.

Configuration—Entering and Exiting Configuration Mode

 Press and hold the configuration button for 2 seconds to enter or exit the configuration mode.

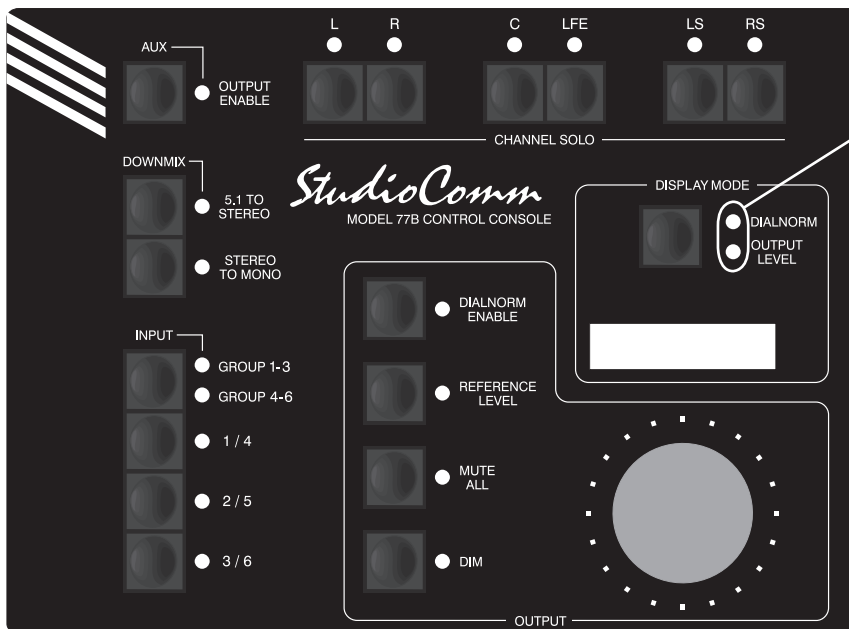
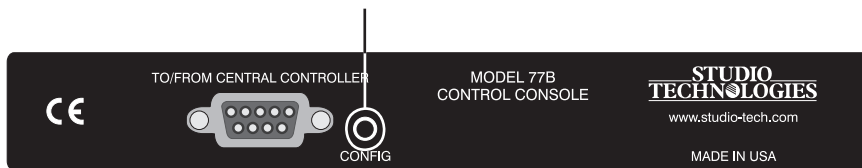

Configuration—Model 77B Device Address and Auxiliary Monitor Output Nominal Level

-  Press and hold the Auxiliary Output Enable button to display and select the Model 77B's device address and auxiliary monitor output nominal level.

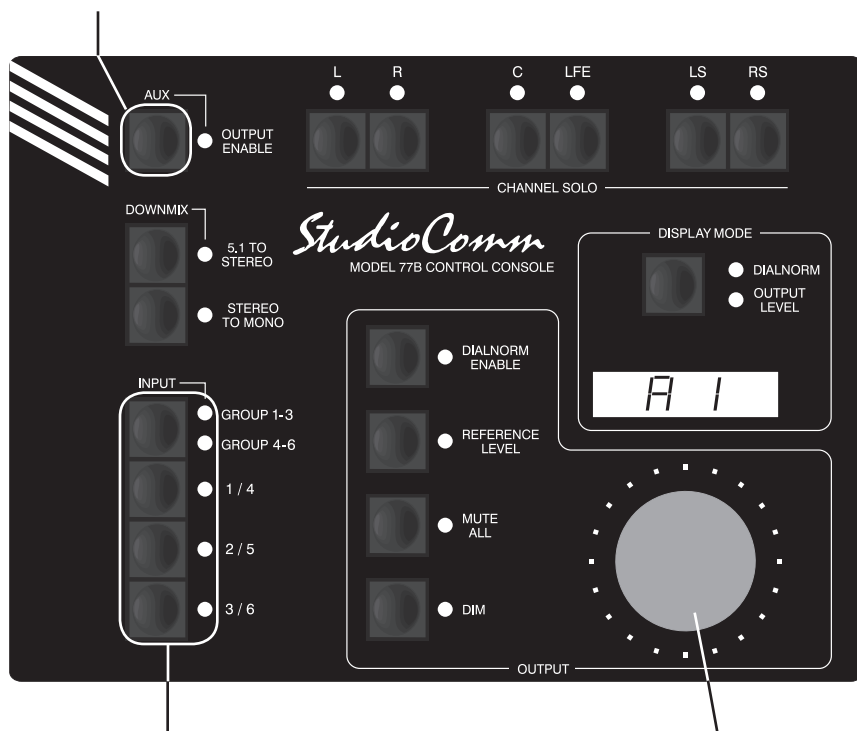

When the Auxiliary Output Enable button is pressed, use the input buttons to select the nominal level of the **auxiliary monitor output**. When LED Group 1-3 is lit the output level is +4.0 dBu. When LED 1/4 is lit the output level is 0.0 dBu. When LED 2/5 is lit the output level is -6.0 dBu. When LED 3/6 is lit the output level is -12.0 dBu.

Use the level control to change this specific **Model 77B's device address**. Address can be either A1, A2, A3, or A4.

Default: Device address A1.
+4.0 dBu auxiliary monitor output nominal level.

Note: The Model 77B's device address is the only parameter stored in the Model 77B. All other parameters are stored in the Model 76B.

Configuration—Digital Input Reference Level and Monitor Output Nominal Level

When the Mute All button is pressed, use the Channel Solo L and R buttons to select the **monitor output nominal level**. Use the buttons to change the configuration. L LED lit means nominal level is 0.0 dBu; R LED lit means nominal level is +4.0 dBu.

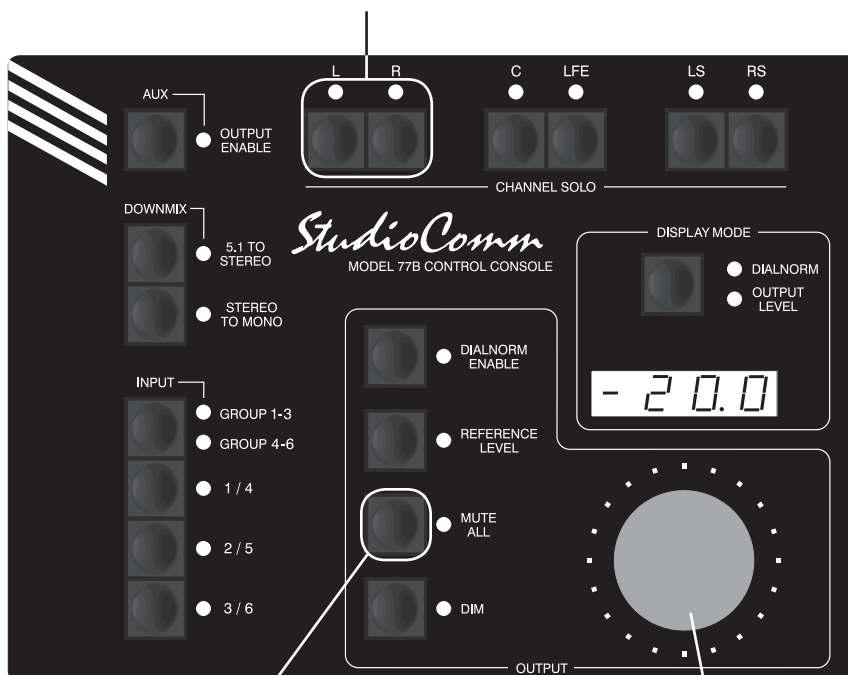

Press and hold the Mute All button to display and select the digital input reference level and monitor output nominal levels.

When the Mute All button is pressed, use the level control to adjust the **digital input reference level**. Available digital input reference levels are -20.0 dBFS, -18.0 dBFS, -16.0 dBFS, and -14.0 dBFS.

Default: -20.0 dBFS digital input reference level.
+4.0 dBu monitor output nominal level.

Configuration—Input Select Buttons

When an input button is pressed use the L and R buttons to assign **stereo input A** to that button. Both L and R LEDs lit means stereo input A is assigned to that button as a stereo source. L LED only lit means channel 1 of stereo input A is routed to the center output and channel 2 is not used. R LED only lit means channel 2 of stereo input A is routed to the center output and channel 1 is not used.

When an input button is pressed use the C and LFE buttons to assign **stereo input B** to that button. Both C and LFE LEDs lit means stereo input B is assigned to that button as a stereo source. C LED only lit means channel 1 of stereo input B is routed to the center output and channel 2 is not used. LFE LED only lit means channel 2 of stereo input B is routed to the center output and channel 1 is not used.

When an input button is pressed use the LS button to assign **stereo input C** to that button. Both LS and RS LEDs lit means stereo input C is assigned to that button as a stereo source. Individual stereo input C channels cannot be routed to center output.

When an input button is pressed use the 5.1 to Stereo button to assign **surround input A** to that button. Use the Stereo to Mono button to assign **surround input B** to that button.

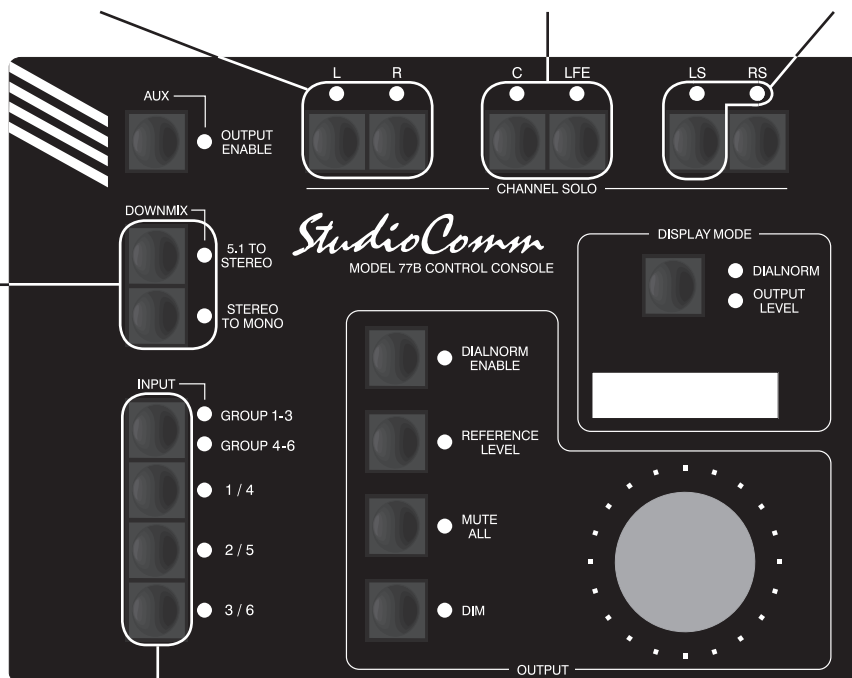

Press and hold an input to display and select which input source is assigned to that button in Group 1-3. Press and hold both the group select button and an input button to display and select which input is assigned to that button when Group 4-6 is active.

Default: Surround input A assigned to input 1.
Surround input B assigned to input 2.
No input assigned to input 3 (disabled).
Stereo input A assigned to input 4.
Stereo input B assigned to input 5.
Stereo input C assigned to input 6.

Note: If no input is assigned to an input button that button is disabled.

Configuration—Reference Level

-  Press and hold the Reference Level button for 5 seconds to take a “snapshot” of the level control’s setting at the time configuration mode was entered. The Reference Level LED will flash when the button is initially pressed and then light solid when the “snapshot” has been taken.

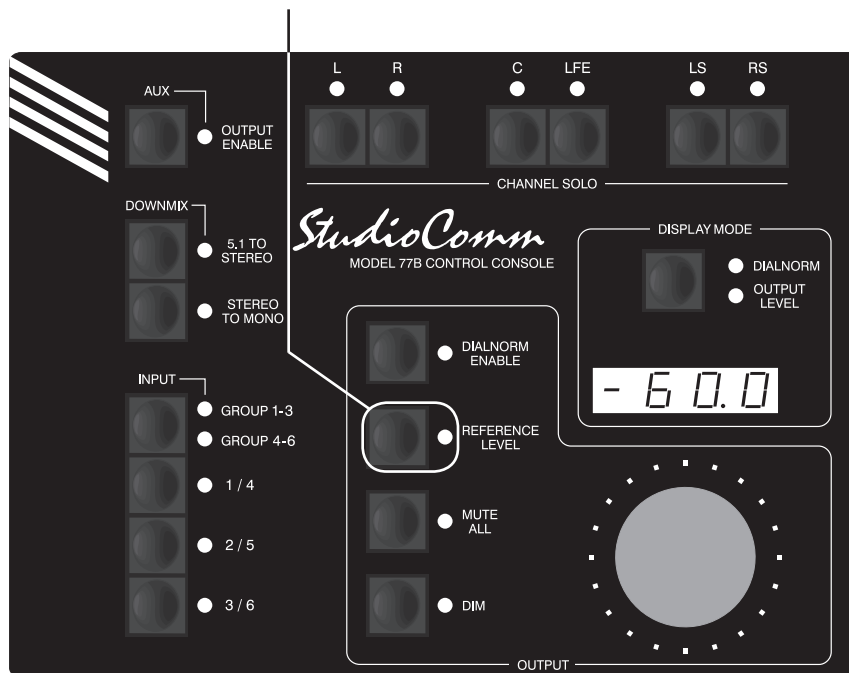

Default: Reference level set for –60.0 dB monitor output level.

Note: The 5-second delay is a safety feature ensuring that the reference level will not be accidentally changed. To permanently store the new value, you must still exit the configuration mode.

Configuration—Overall Display Mode and Reference Level in dB SPL

When the Display Mode button is pressed, use the Channel Solo L and R buttons to select the **overall display mode**. L LED lit means attenuation mode is selected; R LED lit means SPL mode is selected. Use the buttons to change the configuration.

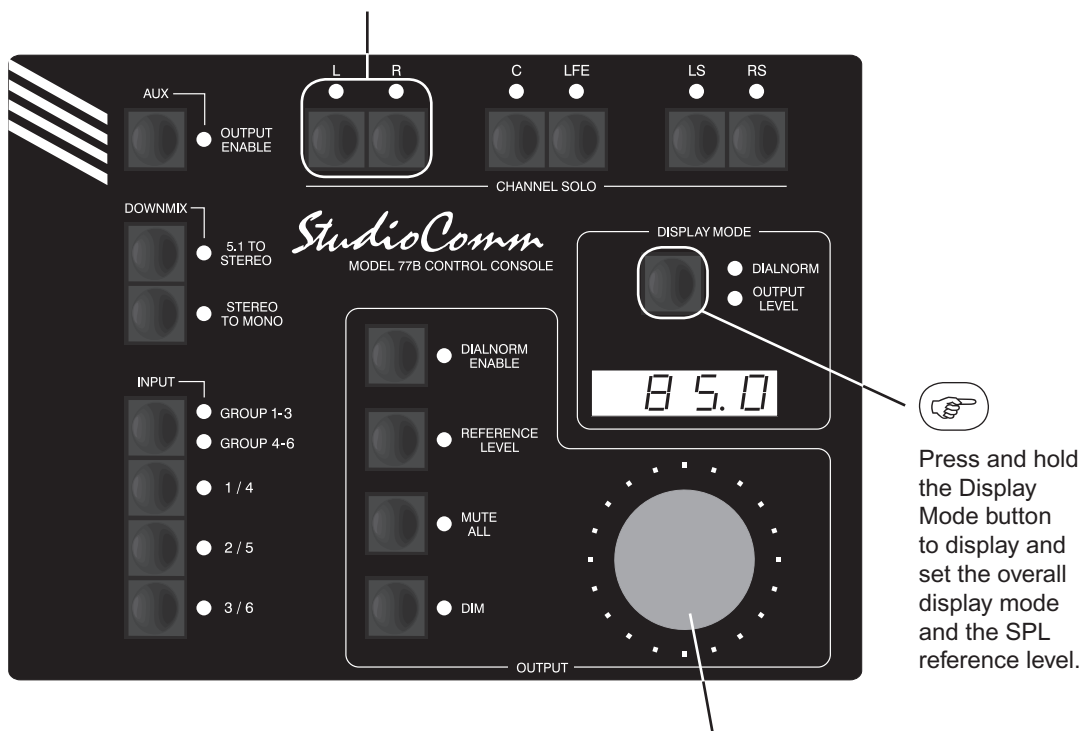

When the Display Mode button is pressed, use the level control to adjust the **SPL reference level**. The range is 70.0 to 100.0 dB in 1.0-dB steps.

Default: Attenuation display mode selected.
85.0 dB SPL reference level.

Configuration—Dialnorm Reference Level and Dialnorm Data to Surround Input Assignment

When the Dialnorm Enable button is pressed, use the Downmix 5.1 to Stereo and Stereo to Mono buttons to **assign the dialnorm data to the appropriate surround input**. LED 5.1 to Stereo lit means dialnorm data assigned to surround input A. LED Stereo to Mono lit means dialnorm data assigned to surround input B.

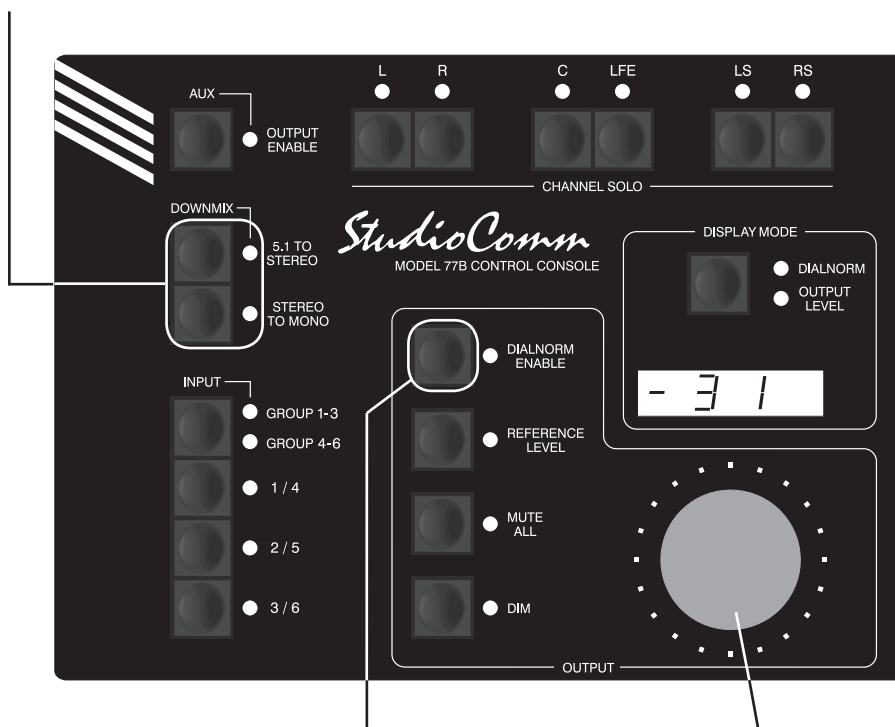

Press and hold the Dialnorm Enable button to display and set the dialnorm reference level and assign the dialnorm data.

When the Dialnorm Enable button is pressed, use the level control to adjust the **dialnorm reference level**. The range is -31 to -1 dB in 1-dB steps.

Default: -31 dB dialnorm reference level.
Dialnorm data assigned to surround input A.

Configuration—Dim Level, Remote Mute All, Remote Dim, and Remote Auxiliary Monitor Output On/Off

This LED displays the configuration of **remote mute all**. LED not lit means remote mute all is disabled; LED lit means enabled. Use the button to change the configuration.

This LED displays the configuration of **remote dim**. LED not lit means remote dim is disabled; LED lit means enabled. Use the button to change the configuration.

This LED displays the configuration of **remote auxiliary monitor output on/off**. LED not lit means remote auxiliary monitor output on/off is disabled; LED lit means enabled. Use the button to change the configuration.

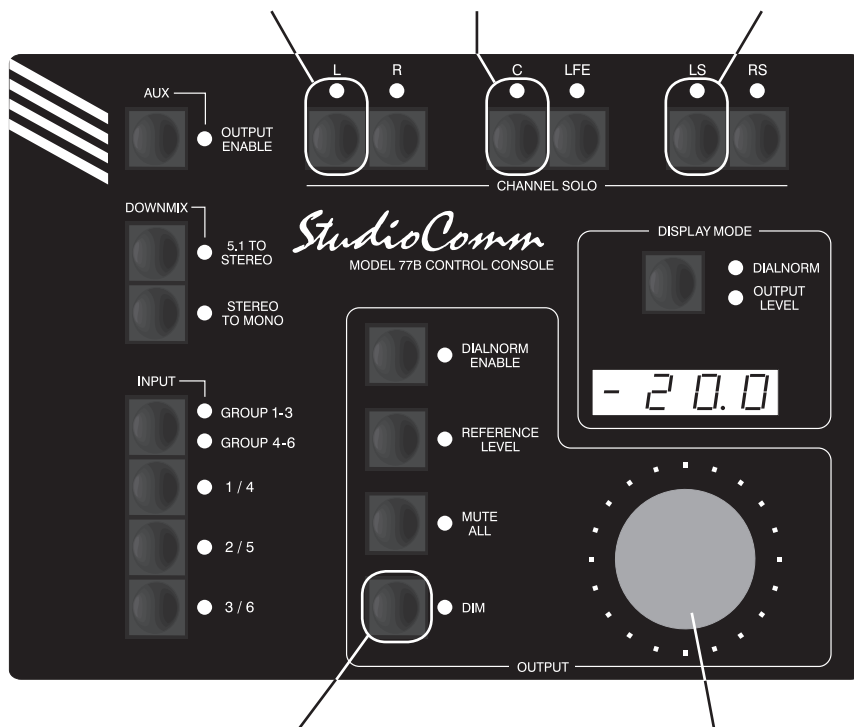

 Press and hold the Dim button to display and select the dim level, remote mute all, remote dim, and remote auxiliary monitor output on/off configurations.

When the Dim button is pressed, use the level control to adjust the dim level. Available dim levels are -10.0 dB, -15.0 dB, -20.0 dB, and -25.0 dB.

Default: -20.0 dB dim level.
Remote mute all disabled.
Remote dim disabled.
Remote auxiliary monitor output on/off disabled.

Configuration—Channel Pop Solo Mode Offset Levels



Press and hold the 5.1 to Stereo button to display and select the channel pop solo up offset level.



Press and hold the Stereo to Mono button to display and select the channel pop solo down offset level.

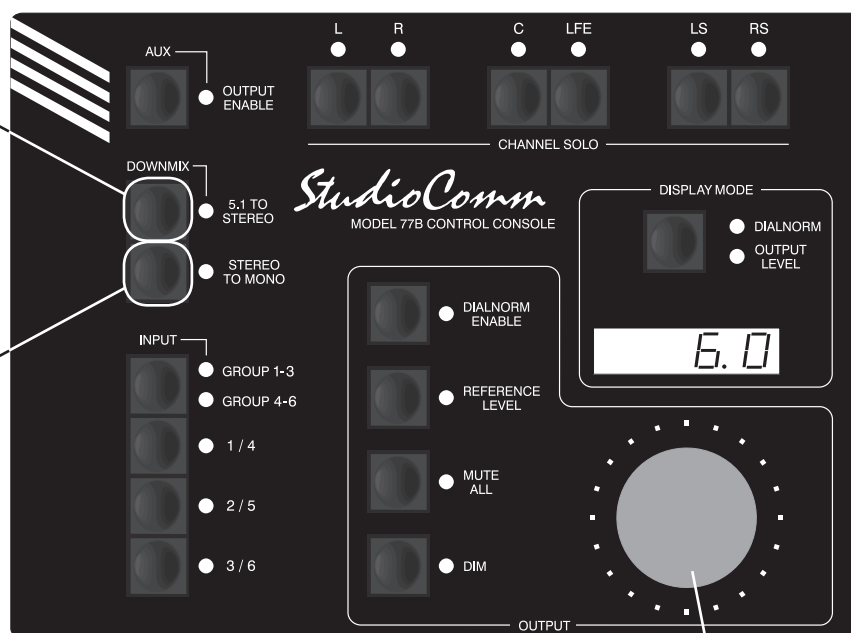

When the 5.1 to Stereo button is pressed, use the level control to adjust the **channel pop solo up offset level**. The range is 0.0 to 12.0 in 0.5-dB steps.

When the Stereo to Mono button is pressed, use the level control to adjust the **channel pop solo down offset level**. The range is -0.0 to -12.0 in 0.5-dB steps and full mute. Full mute is selected by adjusting the level control past -12.0, at which point the display will show - - - -.

Default: 6.0 dB channel pop solo up offset level.
-6.0 dB channel pop solo down offset level.

Configuration—Restore Factory Defaults



Press and hold both the Dialnorm Enable and Dim buttons for 5 seconds to restore Model 77B factory defaults. Once defaults have been restored, the associated LEDs will light. After the buttons are released, configuration mode will be exited and normal operation will resume.

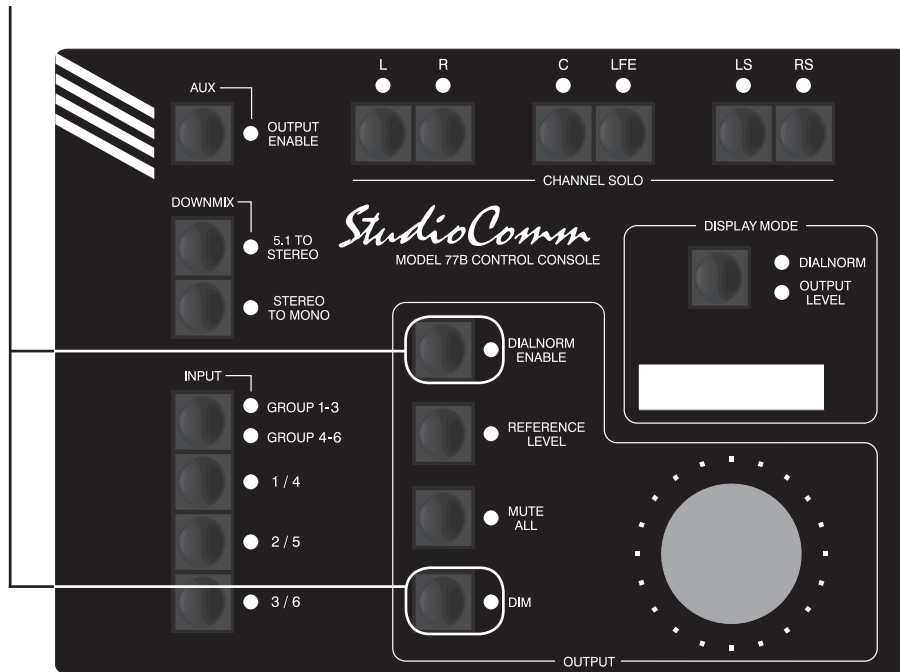

Factory Defaults:

Device address A1.

+4.0 dBu auxiliary monitor output nominal level.

-20.0 dBFS digital input reference level.

+4.0 dBu monitor output nominal level.

Surround input A assigned to input 1.

Surround input B assigned to input 2.

No input assigned to input 3 (disabled).

Stereo input A assigned to input 4.

Stereo input B assigned to input 5.

Stereo input C assigned to input 6.

Reference level set for -60.0 dB monitor output level.

Attenuation display mode selected.

85.0 dB SPL reference level.

-31 dB dialnorm reference level.

Dialnorm data assigned to surround input A.

-20.0 dB dim level.

Remote mute all disabled.

Remote dim disabled.

Remote auxiliary monitor output on/off disabled.

6.0 dB channel pop solo up offset level.

-6.0 dB channel pop solo down offset level.

Warning: Each Model 77B unit must have a unique address. Restoring factory defaults will reset only this specific Model 77B to address A1. If another connected unit is already configured for address A1, normal system operation will stop.

Note: The 5-second button-press delay is a safety feature ensuring that the factory defaults will not be accidentally restored.

Operation

Now that you've installed and configured the system, you're ready to go. You should find operation very easy. However, taking time to study this section of the guide may prove valuable, especially regarding the system's support for dialnorm.

Upon power up the system will return to the last operating condition, including all selected sources, downmix modes, etc. As a precaution, however, the monitor output level will always return to its minimum value. The rotary level control or the reference level button must then be used to return the system to the desired monitor output level.

Model 76B Central Controller

The Model 76B's front panel contains three LEDs. The power LED should be lit whenever AC mains power is connected. The control console activity LED will light steadily whenever the Model 76B is communicating correctly with the one or more connected Model 77B units. This LED will remain off during the system power-up process, something that typically takes several seconds to complete. The metadata activity LED will light whenever an active metadata signal has been connected and valid sync word information is being received.

Model 77B Control Console

StudioComm for Surround operation is controlled using Model 77B Control Consoles and, if connected, the metadata and remote control inputs. In most installations only one Model 77B will be present but, as previously discussed, up to four can be connected to one Model 76B. To make things easy to describe, we've divided the

operator functions into seven main groups: input source selection, downmix, monitor output general functions, channel solo, auxiliary monitor output, display and display mode, and remote control inputs.

Any change made to any one Model 77B will be reflected in the status LEDs and displays on all the connected units. And note that all Model 77B units function simultaneously—there is no priority of one unit over the others.

Input Source Selection

Four input select buttons work together to allow monitoring of up to six input sources. One button serves as a group select while the other three select the specific input. The group select button is used to select the active group, alternating between groups 1-3 or 4-6. Two LEDs are associated with this button and indicate which of the groups is active. The other three buttons are used to select the specific input source to be monitored. The choices are 1/4, 2/5, and 3/6, with the active input following the status of the group select function. LEDs are associated with the input select buttons and indicate which is active. Note that the Model 77B "remembers" which specific input was last selected for each group, so changing between groups will switch between two specific inputs. This allows rapid switching between, as an example, input 1 and input 6.

The specific sources assigned to the input buttons depend on the signals connected to the Model 76B along with how the system has been configured. Any input can be assigned to any input select button. (Technically, the same input could be assigned to multiple buttons!) This means, for example, that a surround input could

be monitored using any of the input select buttons. The same holds true for a stereo, dual channel, or monaural input source.

Downmix

Two downmix functions allow users to perform “real-world” audio format compatibility checks. One function allows a surround (5.1) signal to be “folded down” (mixed) to stereo (2-channel). The other allows a stereo signal to be converted to mono. Using the downmix functions simply requires pressing the desired button. The buttons are set to always “latch” the functions on and off. An LED is located adjacent to each button and lights whenever its respective function is active. Please refer to the Technical Notes section of this guide for a detailed description on how the downmix functions perform their tasks.

5.1 to Stereo

When the 5.1 to stereo downmix function is enabled the LS, RS, and C channels associated with a surround signal are combined (“folded down”) with the L and R signals to create a 2-channel stereo (left and right) signal. The resulting stereo signal, sometimes known as LoRo, is routed to the L and R surround monitor output channel. The C, LFE, LS, and RS monitor output channels are muted. By utilizing this downmix function phase relationships and inter-channel level issues can be quickly observed.

Stereo to Mono

The stereo to monaural downmix function combines the left and right audio channels to create a single-channel monaural signal. This signal is sent out the C (center) monitor output channel while the L, R, LS, RS, and LFE channel monitor output channels are muted.

Note that when a surround source is selected for monitoring, the 5.1 to stereo downmix function will automatically enable whenever the stereo to mono downmix function is enabled. This ensures that an operator will hear a mono signal created by folding down all channels associated with the selected surround input. The Model 77B associates the state of the downmix functions with the currently selected input. For example, if input 4 is the selected input source and the 5.1 to stereo downmix function is enabled, this condition will be “remembered” when switching to a stereo or monaural input source. Upon returning to input 4, the 5.1 to stereo downmix function will again become active.

Note that a specific downmix function can only be enabled when it is applicable for the currently selected input source. This means that the 5.1 to stereo downmix function can only be enabled when a surround (5.1) input source is selected. Neither of the downmix functions can be enabled when an input source configured for monaural is selected. This is because an input of this type is already monaural (one channel) and wouldn’t be impacted by any additional fold down.

Monitor Output General Functions

Four buttons and one rotary control are associated with the surround monitor output functions. The buttons control operation of the reference level, mute all, dim, and dialnorm enable functions. The rotary level control is used to manually set the monitor output level. These buttons and the control do not impact the auxiliary monitor output.

Reference Level

The reference level button sets the surround monitor output level to a preset value. Technical personnel, using a sound-pressure-level (SPL) meter and precision signal source, should have set this level to meet the requirements of the specific monitoring environment. The LED associated with the reference level button will light whenever the function is active. Whenever the reference level mode is active the rotary level control is disabled. The 4-digit display will indicate the reference output level. Note that the system's default reference level is -60.0 dB so "out of the box" the Model 77B will display **-60.0** when reference level mode is enabled.

The reference level LED also serves as a calibration aid. If the reference level mode is not active, whenever the monitor output level is precisely the same as that stored for the reference value the reference LED will flash. The monitor output level can reach this exact level through the use of the rotary level control by itself or through the setting of the rotary level control in conjunction with the dialnorm data and dim function. Whatever path the output level takes to reach the reference level value, it will cause the reference level LED to flash!

Mute All

Pressing the mute all button causes the six channels associated with the surround monitor output to mute. The 4-digit display indicates the mute condition by showing four horizontal dashes. The mute all button is always set to "latch" the function on and off. The LED associated with the mute all button will light whenever mute all is active. Note that if mute all is enabled via the remote mute all function, the mute all LED will flash. Also, the mute all function does not impact the auxiliary monitor output.

Dim

The dim function is provided for user convenience, allowing the surround monitor output level to be reduced by a fixed amount. The Model 77B's configuration mode allows the dim level to be selected from among four choices: -10.0 , -15.0 , -20.0 , or -25.0 dB. Pressing the dim button will enable the function. The dim button is always set to "latch" the function on and off. The 4-digit display, when selected for output level mode, will indicate the revised monitor output level. If the requested "dimmed" output level is equal to or less than the minimum attenuated level, the monitor output will go into full mute and the display will show four horizontal dashes. When dim is active the monitor output level reduction will apply no matter whether the monitor output level is being set by the rotary level control or by the reference level button. The LED associated with the dim button will light whenever dim is active. If dim mode is enabled via the remote dim function the dim LED will flash.

It's worth using a few sentences to discuss the auto dim off function. Whenever dim is enabled due to the dim button being pressed, as well as the rotary level control being active (reference level mode is not active), changing the setting of the rotary level control will automatically turn off dim. The auto dim off function is a unique attempt at protecting the aural health of users. No longer will there be a heart-stopping blast of audio when the dim button is pressed, supposedly to enable dim, but actually turning dim off because it was already enabled. It's hard to explain unless you've experienced this in person—trust us, this situation can and does happen!

Note that the auto dim off function is not active whenever dim is enabled due to the remote dim function being active. This allows remote control equipment, such as a talkback system, to reliably dim the monitor outputs.

Dialnorm Enable

Enabling the dialnorm level function simply requires pressing the dialnorm enable button. The button provides a “latching” function so that the selected state is maintained. An associated LED will light whenever the function is active. The dialnorm enable function can only be activated when the selected input source is a surround signal that has been configured as having dialnorm associated with it. (This is because dialnorm level data is available only for that specific source.) When enabled, as the dialnorm level changes the monitor output level will automatically increase or decrease as appropriate. During configuration of the system a dialnorm reference level was entered. This level, typically in the range of -27 to -24 dB, is compared to the incoming dialnorm level value. If the current dialnorm level is less than the reference value the output level is increased by the difference. If the current dialnorm level is greater than the reference value the output level is decreased, again by the difference. Note that dialnorm levels are limited to a range of -31 to -1 dB. This restricts the maximum amount of level control to 30 dB.

The 4-digit display, when selected for output level display mode, will display all level changes as they occur, including level changes due to dialnorm activity. The current dialnorm level value can itself be viewed by selecting the display dialnorm mode.

In either display mode the decimal point “dot” in the lower-right corner of the 4-digit display will light whenever the current dialnorm value matches the dialnorm reference value. This topic is described in greater detail in the Display and Display Mode section later on in this section. The Technical Notes section of this guide also will provide additional useful information about dialnorm.

Rotary Level Control

The rotary level control is used to manually adjust the surround monitor output level. It is active whenever the reference level function is not active. The level control provides the ability to adjust the monitor output level over a 70 dB range. Technically the rotary level control is a 24-step-per-revolution mechanical encoder. The amount of level change in dB per step (“click”) will depend on how quickly the control is turned. When changed slowly, each step represents a 0.5 dB change in level. In this case, to traverse the entire level range would require rotating the control more than four full turns. But the Model 77B’s software detects when the control is rotated more quickly and increases the amount of level change in dB per step. A little experimentation will allow the user to acquire a good “feel” for how best to use the control. The reference LED will flash when the rotary level control sets the output level to be the same as the stored reference level. Whenever the rotary level control is used to set the output level for minimum, the monitor output channels will automatically mute. Technically, this has the same effect as when the mute all function is active.

Channel Solo

The channel solo function allows specific channels to be selected for individual or group “solo” monitoring. The function takes place electrically “after” the input source selection, downmix, and level control functions. Two solo modes are available, normal and channel pop. In the normal solo mode the level of a channel selected for soloing actually doesn’t change; the solo function causes the non-soloed monitor output channels to mute. In the channel pop solo mode the level of the soloed channel will increase, while the level of the non-soloed channels will decrease. In this way the soloed channel will “pop out” from an audio mix so as to be more easily observed. The actual level changes that occur in pop solo are dependent on how the system has been configured.

Six buttons and associated LEDs, along with the auxiliary monitor output enable button, are associated with the channel solo function. To solo a channel simply requires pressing one of the solo buttons. The buttons function in a press-to-enable/press-to-disable “latching” mode. The LED associated with a soloed channel will flash to indicate that solo is active. The auxiliary monitor output enable button is used to select the solo mode. Using this button the solo mode can be changed any time between normal and channel pop. Simply press and hold the auxiliary monitor output enable button for a few seconds until all the channel solo LEDs light in the desired manner; steady for normal solo mode and flashing for channel pop solo mode. Once the state of the LEDs change (steady-to-flashing or vice-versa) the desired solo mode becomes active and the button can be released. The selected solo mode will

be maintained even after the system is powered down and subsequently powered up.

Note that there is a potential downside of having to use the auxiliary monitor output enable button to change the solo mode. Whenever the button is pressed the on/off status of the auxiliary monitor output will change too. While this may be a bit odd and possibly inconvenient, it hopefully won’t prove to be a big issue. It’s simply an artifact of “multi-tasking” the button’s function. Once the solo mode has been selected the auxiliary monitor output enable button can be “tapped” to select the desired on/off condition.

For user flexibility, more than one output channel can be selected for soloing at a time. The Model 77B even allows all six monitor output channels to be simultaneously selected for solo. This would seem to be an “all soloed so none are soloed” mode. But this condition is specifically allowed so that an output channel mute function can be provided. By first soloing all output channels an operator can then “un-solo” specific channels, directly muting them. It’s a bit confusing to describe in words but is very simple to use and can be very useful resource—try it out and you’ll see! But note that while you can always solo all channels, it’s really more useful to do this when the system is configured for normal solo mode. If selected for the channel pop solo mode, soloing all the channels won’t provide a very useful function.

Auxiliary Monitor Output

As has been previously discussed in this user guide, the auxiliary monitor output is a stereo (2-channel) output signal that can be used for special applications. The source for this output is stereo input C. Using the auxiliary monitor output enable button it can

be routed to the auxiliary monitor output as desired. The button functions in an alternate action manner to change the current state of the output. An associated LED lights whenever the auxiliary monitor output is active. No level control, downmix, or other Model 77B-supported functions will impact the auxiliary monitor output.

Display and Display Mode

The Model 77B's 4-digit LED display can be selected to show either the level of the surround monitor output or the dialnorm level. The display mode button is used to select the desired mode. Two LEDs are associated with this button, indicating which mode is active.

Both modes will indicate level in dB. What the digits actually represent will depend on how the Model 77B has been configured. When selected for the output level display mode, the surround monitor output level will be shown as either the amount of attenuation or the sound pressure level (SPL). If configured for the attenuation mode the display will show the output level as an attenuation value in reference to the maximum output. This is in the form of 0.5-dB steps less than the maximum of 0.0 dB. So a display of -40.5 would indicate that the surround monitor output is set to be 40.5 dB below the maximum level. As the rotary level control is moved counterclockwise the output level will go down and the indicated value will get more negative.

If the Model 77B is configured to display the output level in SPL, the 4-digit display will always show the output level in positive numbers. These numbers are intended to represent the sound pressure level in dB SPL, a figure that should directly relate to the actual sound pressure level that the

loudspeaker system is presenting to users. (Typically, the level value would actually be in dBC, the C-weighted sound pressure level.) When the reference level button is enabled, or the rotary level control is set so that the reference level has been reached, the display will typically show something in the range of 82 to 87 dB. Assuming that the monitoring environment has been correctly calibrated, this would indicate that an average listening level of 85 dB, for example, had been achieved.

When the 4-digit display is set for the dialnorm display mode a much different piece of information will be shown to the user. It will show the somewhat obscure but important dialnorm level parameter that's associated with a surround input source. As has been covered in other parts of this guide, dialnorm is intended to provide a numeric value that represents the average dialog level associated with an audio-for-picture element. Technically, dialnorm values can range from -31 to -1 dB but during actual operation they will typically be in the range of -30 to -20 dB. The value may change relatively frequently in conjunction with changes to the actual audio signal. This would be the case, for example, with a television program that consists of alternating program and advertising segments. In other situations the dialnorm level will only change when an "on-air" source is switched from typical station-originated segments to an extended-duration broadcast program, such as a live concert event. And on the extreme end, in some facilities the dialnorm level is fixed and won't ever change. That's not really in the spirit of what dialnorm is supposed to accomplish, but *c'est la vie*. Whatever the dialnorm level—the Model 77B will display it!

In both display modes a special feature is provided to assist users in knowing if the

current dialnorm level matches a facility's "house" reference. This reference level, typically in the range of -24 to -27 dB, is entered as part of the Model 77B's configuration process. The "dot" in the lower-right corner of the 4-digit display will light whenever the current dialnorm level matches the stored reference level. Refer to Figure 7. This feature can be useful in broadcast transmission and distribution applications. In theory, any time the dot in the lower-right corner is not lit the current dialnorm level value is causing a level adjustment to take place. This level adjustment may be taking place in the StudioComm system, if the dialnorm enable function is active, as well as in downstream users of the broadcast signal.

Note that if a valid dialnorm source is not available the 4-digit display, when selected to display dialnorm, will show four horizontal bars. This could be due to a problem with the metadata signal connected to the Model 76B Central Controller. But more frequently this will simply be the normal result that occurs when the Model 77B's input is not selected for the metadata-associated surround input source.

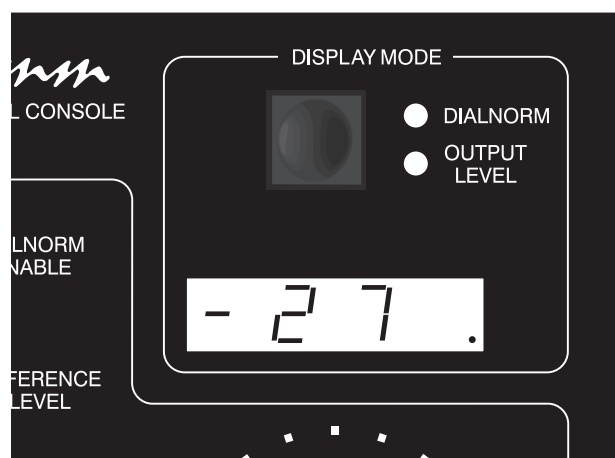

Figure 7. Incoming dialnorm level match "dot"

As has been previously discussed, the channel pop solo mode offers a unique way of sonically highlighting an individual channel. A channel selected for soloing in this mode will have its level increased while the other non-soloed channels will be reduced in level. To highlight this condition the letters POP will appear in the 4-digit display whenever a channel is actively being soloed in the channel pop solo mode. This ensures that a user will understand that the monitor outputs no longer represent the true inter-channel level relationships.

Remote Control Inputs

Three remote control signals can be connected to the StudioComm system and configured for operation. The functions are remote mute all, remote dim, and remote auxiliary monitor output on/off. When an external signal activates remote mute all the LEDs on the Model 77B associated with the mute all button will flash. If mute all was already active when the remote mute all function is activated, the LED will change from being steadily lit to flashing.

When an external signal activates remote dim the LED on the Model 77B associated with the dim button will flash. If dim was already active when remote dim is activated, the LED will change from being steadily lit to flashing.

When an external signal activates remote auxiliary monitor output the LED associated with the auxiliary monitor output enable button will flash. If the auxiliary monitor output was already active when remote auxiliary monitor output on/off is activated, the LED will change from being steadily lit to flashing.

Technical Notes

Dialnorm

A source of Dolby E metadata can be connected to the Model 76B Central Controller. Within this flow of metadata frames can be a “dialnorm” level value that’s associated with one of the Model 76B’s 5.1 surround input signals. When this surround input is selected for monitoring its associated dialnorm level value can be displayed by the Model 77B Control Console. It can also be used to control the level of the surround monitor output.

Technically, the metadata is in the form of a 115.2 kbit/s RS-485/RS-422 signal that contains a number of data elements, including one or more that represent the average dialog level (dialog normalization or dialnorm) in the audio program signals being carried over the digital audio portion of the related Dolby E interface. These dialnorm levels are associated with specific programs within the 8-channel audio “stream.” Firmware within the Model 76B is able to parse (separate) the data elements, specifically separating the first dialnorm level value in the metadata frame from the one or more that may be present later in the frame. To clarify, any dialnorm level elements that occur later in the same metadata frame are ignored. This method was selected as it was assumed that the first dialnorm level element will always be associated with a 5.1 program. There’s a technical basis for why this should be true. In Dolby E a 5.1 program is always assigned to the first six channels (channels 1-6). While there may be separate dialnorm values associated with audio channels 7 and 8, they are not relevant for correct StudioComm system operation.

Downmix

The downmix functions are implemented in the Model 76B Central Controller’s hardware using analog circuitry. The 5.1 to stereo downmix function performs this action: center (C) input dropped in level by 6 dB and routed to the left (L) and right (R) surround monitor outputs; left surround (LS) input dropped in level by 3 dB and routed to the L surround monitor output; right surround (RS) input dropped in level by 3 dB and routed to the R surround monitor output; low-frequency-enhancement (LFE) input is muted; C, LFE, LS, and RS surround monitor output channels are muted. The resulting stereo signal is sometimes known as LoRo.

The stereo to mono downmix function performs this action: L input dropped in level by 3 dB and routed to the C surround monitor output; R input dropped in level by 3 dB and routed to the C surround monitor output; C, LS, RS, and LFE inputs mute.

“Hot” Disconnection of the Model 77B Control Consoles

There’s no problem relocating one or more Model 77B Control Consoles while the StudioComm system is operating. You can disconnect the 9-pin interconnecting cable, move the unit (or units), and then re-connect without issue. Upon disconnection of all control consoles the Model 76B Central Controller will mute the monitor output channels as well as saving the current operating parameters. No clicks, pops, or other noises will occur when the Model 77B units are again connected. The Model 77B units will go through their standard power-up sequence and then normal operation will resume.

Monitor Output Transient Protection

The Model 76B Central Controller contains a power-up/power-down transient protection feature. This limits the chance of damage to the monitor loudspeakers during the time when AC mains voltage is connected, disconnected, or has changed significantly from nominal. A combination of hardware and software is used to monitor one of the power supply “rails.” Until the AC mains input exceeds its nominal operating voltage range, electromechanical relays maintain a short-circuit condition on the monitor outputs. After the input voltage is recognized as valid, a short delay takes place before the relays are allowed to function normally. Whenever the AC mains input drops below its nominal operating voltage range, the relays immediately go to their mute state. During testing it was found that upon power up the monitor outputs remained very quiet; during power down a small to moderate “tick” was the worst that was heard.

Model 76B to Model 77B Connections

Figure 6 gives a detailed description of the signals that connect the Model 76B Central Controller to the one or more Model 77B Control Consoles. The Model 76B provides a +12 volt DC power source for use by the Model 77B’s circuitry. The DC output is current-limited to minimize the chance that a short-circuit condition will damage the Model 76B’s circuitry. An asynchronous, bi-directional, data interface links the connected units. The RS-485 hardware connection scheme operates at a rate of 115.2 kbit/s and uses an 8-N-1 data format. The Model 76B communicates

with each Model 77B unit 20 times per second, receiving button and rotary level control information and sending LED and 4-digit display status data.

Mono-to-Center Polarity

It’s worthwhile to note that a polarity inversion takes place whenever the stereo to mono downmix function is active. By design, the left (L) and right (R) input signals experience a 180-degree inversion in the Model 76B’s combining circuitry. This should not cause a problem as monitoring audio signals over a single loudspeaker is considered polarity insensitive. Only during electrical testing would this condition be detected.

Specifications

Model 76B Central Controller

General Audio:

Frequency Response: digital inputs to monitor outputs loaded with 10 k ohms

32 to 48 kHz Sample Rate: 20 Hz-20 kHz
±0.05 dB

88.2 to 96 kHz Sample Rate: 20 Hz-40 kHz
±0.05 dB

176.4 to 192 kHz Sample Rate: 20 Hz to 40 kHz
±0.05 dB; down 0.5 dB at 80 kHz

Distortion (THD+N): 0.004%, ref 1 kHz, +4 dBu output

S/N Ratio: 86 dB, ref +4 dBu output

Dynamic Range: greater than 106 dB

Crosstalk: 104 dB at 1 kHz; 90 dB at 20 kHz,
ref -1 dBFS input

Digital Audio Inputs: 5

Configuration: two surround (5.1) and three stereo (2-channel)

Supported Sample Rates: 32, 44.1, 48, 88.2, 96, 176.4, and 192 kHz

Word Length: 24 bits maximum

Type: AES3id-2001 (SMPTE 276M)

Impedance: 75 ohms, unbalanced

Reference Level: -20.0, -18.0, -16.0, or
-14.0 dBFS, selectable

Sync Source: all inputs independently self-clocking

Monitor Outputs: 8

Configuration: organized as one surround (5.1) and one auxiliary stereo (2-channel)

Type: electronically balanced, compatible with balanced or unbalanced loads

Nominal Level, Surround (5.1): 0 or +4 dBu, selectable

Nominal Level, Auxiliary: -12, -6, 0, or +4 dBu, selectable

Maximum Level: +26 dBu into 600 ohms or greater

Dolby E Metadata Input:

Type: RS-485/RS-422

Data Rate/Format: 115.2 kbit/s, 8-N-1

Remote Control Inputs: 4

Functions: remote mute all, remote dim, auxiliary monitor output on/off, one spare

Type: +5 V logic, activates on closure to system common

Downmix:

Functions: 5.1 to stereo, stereo to mono

5.1 to Stereo: LS @ -3 dB summed with L; RS @ -3 dB summed with R; C @ -6 dB summed with L and R; C, LFE, LS, and RS monitor outputs mute

Stereo to Mono: L @ -3 dB summed with R @ -3 dB to C; L, R, LS, RS, and LFE monitor outputs mute; C input mutes

Control Console Interface:

Power: 12 volts DC, 200 milliamperes maximum

Control Data Type: RS-485

Control Data Rate/Format: 115.2 kbit/s, 8-N-1

Polling Interval: 50 milliseconds

Connectors:

Digital Audio Inputs: 9, 75 ohm BNC (per IEC 60169-8 Amendment 2)

Monitor Outputs: 25-pin D-subminiature female

Control Console: 9-pin D-subminiature female

Metadata and Remote Control Input: 9-pin D-subminiature female

AC Mains: 3-blade, IEC 320 C14-compatible (mates with IEC 320 C13)

AC Mains Requirement: 100, 120, or 220/240 V, ±10%, factory configured, 50/60 Hz, 30 watts maximum

Dimensions (Overall):

19.00 inches wide (48.3 cm)

1.72 inches high (4.4 cm)

8.75 inches deep (22.2 cm)

Mounting: one space in a standard 19-inch rack

Weight: 8.8 pounds (4.0 kg)

Model 77B Control Console

Application: up to four Model 77B Control Consoles can be connected to Model 76B Central Controller (two can be powered by Model 76B)

Power: 12 volts DC, maximum current 100 milliamperes, typically provided by Model 76B Central Controller

Control Data:

Type: RS-485

Data Rate/Format: 115.2 kbit/s, 8-N-1

Connector: 9-pin D-subminiature female

Dimensions (Overall):

7.20 inches wide (18.3 cm)

2.20 inches high (5.6 cm)

5.40 inches deep (13.7 cm)

Weight: 1.7 pounds (0.8 kg)

Specifications and information contained in this User Guide subject to change without notice.

Appendix A—Connection Pin Out Charts

Connections	Signal High (+)	Signal Low (-)	Shield
L	24	12	25
R	10	23	11
C	21	9	22
LFE	7	20	8
LS	18	6	19
RS	4	17	5
Auxiliary L	15	3	16
Auxiliary R	1	14	2

Notes: 1) All signals transformer-coupled digital audio; selectable for AES3 or AES3id compatibility.

2) Connector type on Model 76B is 25-pin D-subminiature female (DB-25F). Installer must provide male (DB-25M). Connector uses 4-40 threaded inserts for locking with mating plug.

3) Wiring scheme follows TASCAM DA-88 convention. Standard DA-88-type wiring harnesses are directly compatible, with the exception of 4-40 screw threads being required.

Connections for Surround and Auxiliary Monitor Outputs

Signal	Pin	Direction
RS-485 Data +	7	Input
RS-485 Data -	2	Input
Data Shield	1	Shield
Remote Mute All	5	Input
Remote Dim	6	Input
Remote Aux Monitor Out On/Off	8	Input
Remote Spare	9	Input
Remote Input Common	4	Common

Note: Connector type on Model 76B is 9-pin D-subminiature female (DE-9F) Connector uses 4-40 threaded inserts for locking with mating plug.

Connector Pin Outs for Metadata and Remote Control Inputs

Signal	Pin	Direction
Data +	1	To/From Model 77B
Data -	6	To/From Model 77B
Data Shield	2	To/From Model 77B
DC +	4	To Model 77B
DC -	9	To Model 77B
DC Power Shield	5	To/From Model 77B

Note: Connector type on Model 76B is 9-pin D-subminiature female (DE-9F). Connector uses 4-40 threaded inserts for locking with mating plug.

Connections between Model 76B and Model 77B

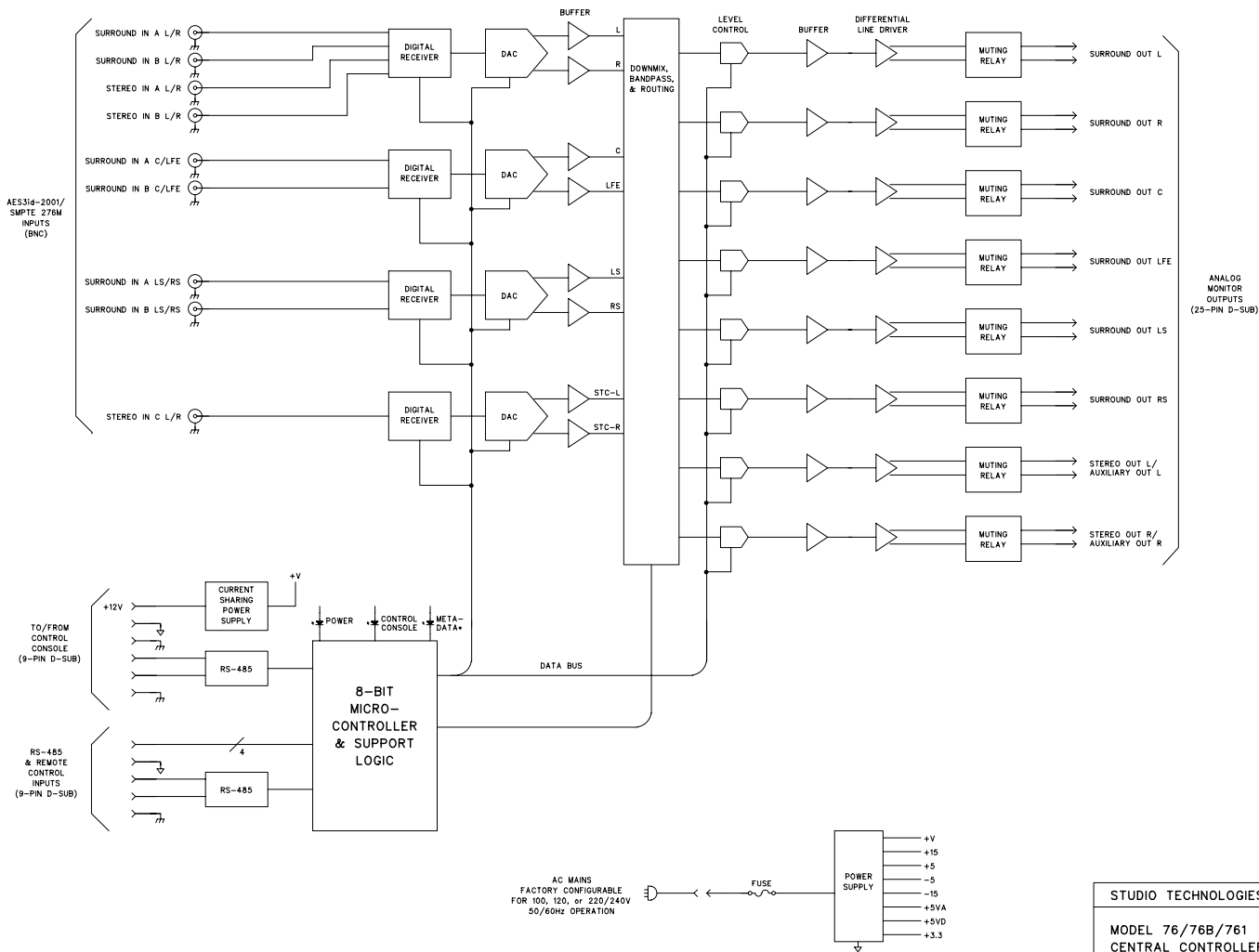

• FOR MODELS 76B AND 761 ONLY

M76BD_C

STUDIO TECHNOLOGIES, INC.		
MODEL 76/76B/761 CENTRAL CONTROLLER BLOCK DIAGRAM		
DRAWING NO.	DATE	PAGE
31308	02/14/08	01 of 01

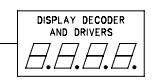
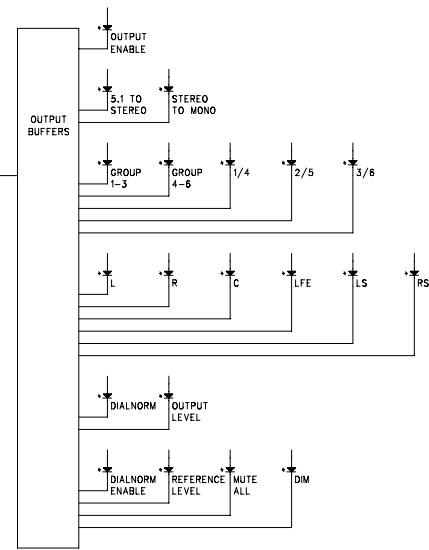
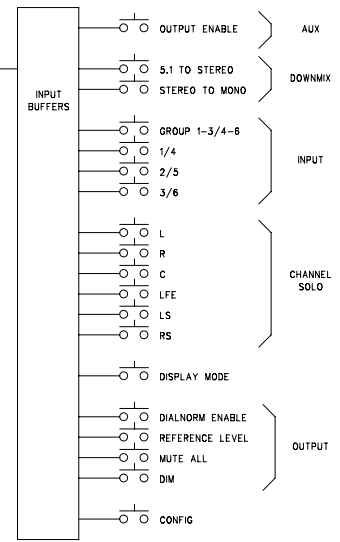
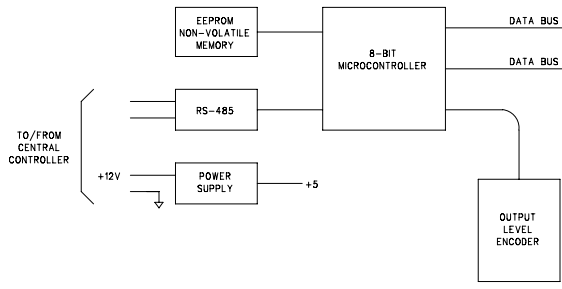

M77BBD_A

STUDIO TECHNOLOGIES, INC.			
MODEL 77B CONTROL CONSOLE BLOCK DIAGRAM			
DRAWING NO.	DATE	PAGE	
31369	03/26/08	01	of 01

