

StudioComm for Surround

Model 76 Central Controller and Model 77 Control Console

User Guide

Issue 6, November 2009

**This User Guide is applicable for systems consisting of:
Model 76: serial number M76-00151 and later with software version 1.10;
Model 77: M77-00151 and later with software version 2.01 and later**

**© 2009 by Studio Technologies, Inc., all rights reserved
www.studio-tech.com**

This page intentionally left blank.

Table of Contents

| | |
|-----------------------------|----|
| Introduction..... | 5 |
| Installation | 8 |
| Advanced Installation | 12 |
| Configuration | 13 |
| Operation..... | 27 |
| Technical Notes | 32 |
| Specifications | 34 |
| Block Diagrams | |
| Model 76 Central Controller | |
| Model 77 Control Console | |

This page intentionally left blank.

Introduction

What This User Guide Covers

This User Guide is designed to assist you when installing and using the Model 76 Central Controller and one or more associated Model 77 Control Consoles.

Overview

As the production of both multi-channel surround (5.1) and 2-channel stereo audio material has become a day-to-day reality, the need for monitoring these sources is imperative for recording, post-production, and broadcast facilities. Studio Technologies has addressed this need with the StudioComm for Surround Model 76 Central Controller and Model 77 Control Console. With its digital audio inputs and analog outputs, it's a simple task to integrate the system into virtually any facility. The carefully selected group of features, including downmix, channel mute/solo, and reference level, make the system both powerful and simple to use. And by using the best of contemporary technology, as well as following rigorous design practices, the system's audio quality is simply excellent. With the StudioComm for Surround system any audio console, disk-based recording system, or broadcast facility can have a complete multi-channel monitor system.

A StudioComm for Surround system starts with the Model 76 Central Controller. It occupies just one rack space but allows connection of two surround (5.1) inputs and three stereo inputs, along with separate surround and stereo monitor outputs. The surround and stereo inputs are digital and compatible with AES3id sources. These unbalanced digital signals utilize BNC

connectors and are ubiquitous in most post-production and broadcast environments. Sample rates of up to 192 kHz and bit depth of up to 24 are directly supported. And with the system's dynamic range of greater than 106 dB, there isn't a problem ensuring that a source's audio quality is maintained. The monitor outputs are analog, balanced line-level, with a maximum signal level of +26 dBu. They include power-up/power-down protection circuitry to help maintain the health of the connected loudspeaker systems.

Digital audio signals are interfaced with the Model 76 using nine BNC connectors. Analog monitor output signal connections are made using one 25-pin D-subminiature connector. An advanced flash-based microcontroller integrated circuit provides the logic "horsepower" for the unit. AC mains power is connected directly to the Model 76, which is factory selected for 100, 120, or 220/240 V operation. The internal power supply utilizes two toroidal mains transformers for quiet audio operation. One 9-pin D-subminiature connector is used to connect the Model 76 with up to four Model 77 Control Consoles. A second 9-pin "D-sub" connector is used to interface remote control signals with the Model 76.

The Model 77 Control Console is the "command center" that is designed to reside at an operator's location. It allows fingertip selection of all monitoring functions. Numerous LED indicators provide complete status information. A 4-digit numeric display indicates the monitor output level in real time. While most installations will use only one Model 77 Control Console, up to four can be connected to a Model 76 Central Controller. This provides multiple users with full control over the monitoring system. Each Model 77

connects to a Model 76 Central Controller using a 9-pin cable. A major strength of the Model 77 is its ability to configure, under software control, many important operating parameters.

Additional Details

The Model 77 provides five buttons and associated LEDs for selection of the surround and stereo input sources to be monitored. While in most cases only one input source will be monitored at a time, stereo input C can be selected for simultaneous monitoring with one of the two surround or other two stereo inputs. This allows the two selected inputs to be combined (“summed”).

The surround and stereo monitor output levels can be controlled by way of a large, easy-to-use rotary control. The level control auto mute all function ensures that the monitor output channels automatically

mute whenever the output level is set to the full attenuation (minimum) position. By using the reference level function, the monitor output level can set to a pre-configured value. This is provided for audio-with-picture applications that require a specific monitor level. The reference level is easily configured by taking an electronic “snapshot” of the desired monitor output level. For operator confirmation a 4-digit LED readout displays the level of the monitor output. It can be configured to display either the attenuation level or the sound pressure level (SPL).

The dim function allows the monitor output level to be reduced by a fixed dB amount. The dim level is selected from four available levels. A mute all function allows all monitor output channels to be simultaneously muted.

The channel mute/solo section provides individual channel control. One pushbutton switch sets the operating mode for either

Figure 1. Model 76 Central Controller Front Panel



Figure 2. Model 76 Central Controller Back Panel

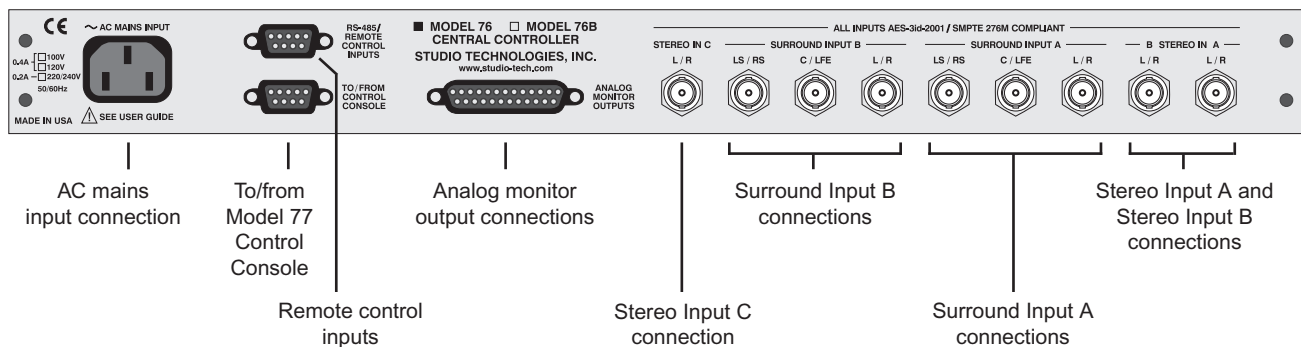

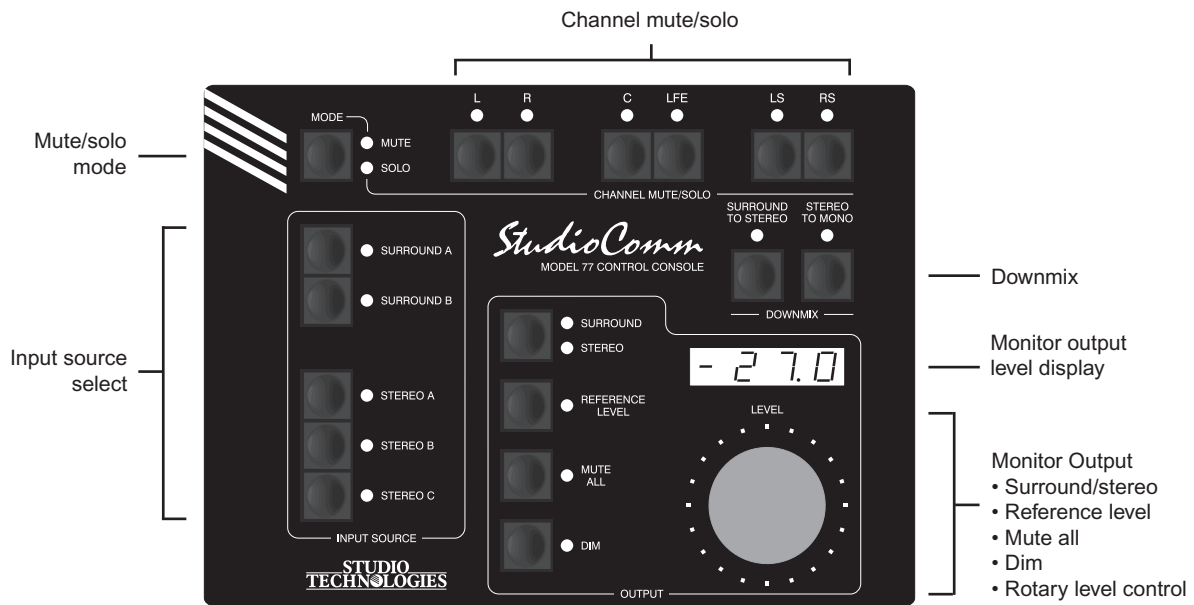

Figure 3. Model 77 Control Console Front Panel

mute or solo. In the mute mode, individual channels can be muted as required. In the solo mode, a single channel can be monitored while the others are automatically muted. Depending on a configuration setting, the mute/solo activity will impact audio either pre (before) or post (after) the downmix functions. In either solo mode multiple channels can be simultaneously selected for “soloing.” The flexibility of having both mute and solo available allows an operator to quickly select the most comfortable and productive operating mode.

A special solo mode is also provided, called channel pop solo, which offers a unique aid in monitoring audio material. Channel pop solo allows the level of a single channel to be raised while the level of the other channels is reduced. This helps to emphasize the content on one channel without fully muting the others. Broadcast applications can benefit from this solo mode, allowing, for example, the center channel to be highlighted while still maintaining some level on the other channels.

The amount of level increase—the “pop”—as well as the amount of attenuation can be configured to meet the needs of specific applications. Note that channel pop solo is only available when the mute/solo function is configured for post downmix.

Two functions allow the format of the monitored sources to be checked for level or phase inconsistencies. The surround to stereo downmix function is used to create a stereo signal from the selected surround (5.1) source. The stereo to mono downmix function allows audio on the left and right channels to be added (summed) and monitored on the center output channel. The two downmix functions can be simultaneously enabled, allowing a surround source to be checked for mono compatibility. A small speaker simulator feature is associated with the stereo to mono downmix function. It is included to assist an operator in determining compatibility with “real-world” playback environments. It functions by placing an audio bandpass filter into the path of the mono signal, simulating the

response of a loudspeaker associated with an inexpensive television or clock radio.

Up to four Model 77 Control Consoles can be connected to a Model 76 Central Controller. The Model 76 can provide power for the first two Model 77 units while an external 12 volt DC source is required for a third and fourth unit. The interconnecting cables use 9-pin D-subminiature connectors that carry RS-485 data and DC power. Remote control signals, including mute all and dim, connect to the Model 76 using a second 9-pin D-sub connector.

For flexibility, the StudioComm for Surround system is designed to easily integrate with equipment such as production intercom systems, on-air or recording tally signals, audio consoles, and film motion-control electronics. Two remote-control input functions are provided: mute all and dim. By providing access to these functions, talkback or slate activity from an audio console or other communications system can control the monitor output level.

While the StudioComm for Surround system for multi-channel monitoring will do many wonderful things, it is not designed to selectively route input signals to the different output channels. An input-channel-to-output-channel relationship is maintained. As an example, a signal that arrives on the center channel of surround input A will output only on the center channel of the monitor output. Any rerouting of the input signals must be done prior to their connection to the StudioComm for Surround system. This should not be a drawback in most facilities, but it's important to highlight this fact.

Installation

In this section you will be installing the Model 76 Central Controller in an equipment rack. Connections to the digital audio inputs and analog monitor outputs will be made. External equipment will be interfaced to the remote control inputs. A location will be selected for the first Model 77 Control Console and it will be connected to the Model 76. AC mains power will be connected to the Model 76.

For advanced applications up to three additional Model 77 Control Console units can be connected to the Model 76. Please refer to the Advanced Installation section of this guide for details.

System Components

The main shipping carton contains one each of the following: Model 76 Central Controller, Model 77 Control Console, 20-foot (6.1 m) 9-pin D-sub interconnecting cable, and user guide. Units destined for North America also include an AC mains cord. Your dealer or distributor should provide an AC mains cord for destinations outside of North America. Any additional Model 77 Control Consoles will be shipped in separate cartons.

Mounting the Model 76

The Model 76 Central Controller requires one space in a standard 19-inch (48.3 cm) equipment rack. Select a location that is convenient for making connections to the digital and analog audio signals as well as interfacing with the Model 77 Control Console. A 20-foot (6.1 m) cable is supplied to connect the Model 76 to the Model 77. If the needs of a specific installation dictate, an alternate-length interconnecting cable

can be fabricated and used. Secure the Model 76 into the equipment rack using two mounting screws per side.

Audio Connections

Audio signal connections are made by way of multiple BNC jacks and a 25-pin D-subminiature connector which are located on the Model 76's back panel. Refer to Figure 2 for a detailed view of the back panel. The BNC jacks will be used for the digital audio signals. A cable assembly with a 25-pin D-sub plug (male) on one end and the desired connectors on the other end will be used for connecting to the analog monitor outputs.

Digital Audio Inputs

The nine female BNC connectors on the Model 76's back panel are used to interface with digital audio signal sources. Each of the digital audio inputs is intended for connection to an unbalanced digital audio source that is compatible with the AES3id-2001 standard. In broadcast environments these signals may also be referred to as following the SMPTE 276M standard. As expected, these signal sources will be provided in the form of coaxial cables with BNC plugs attached. The Model 76 supports sampling rates of up to 192 kHz with a word length (depth) of up to 24 bits. Note that no master external synchronization source is required as each input is independently self-clocking.

Balanced AES3 digital audio signals can also be used with the Model 76's inputs so long as external coupling transformers ("baluns") are utilized. These impedance-matching (110 ohms to 75 ohms) transformer assemblies typically provide a 3-pin female XLR connector on their input and a female BNC connector on their output.

Monitor Outputs

The connector labeled Analog Monitor Outputs provides access to the Model 76's 6-channel (5.1) surround and 2-channel stereo analog monitor outputs. The surround output channels are intended to connect to the main surround loudspeaker system incorporated in a facility. The stereo output allows support for a secondary set of stereo monitor loudspeakers.

The monitor output channels are designed for connection to audio amplifiers associated with monitor loudspeakers, or to the inputs of loudspeakers that contain integrated amplifiers. The monitor outputs are electronically balanced and capable of driving balanced or unbalanced loads of 600 ohms or greater. While balanced operation is preferred, unbalanced operation does not pose a problem. To connect to an unbalanced load connect the + terminal as signal high, and both the - and shield terminals as the signal low/shield. For optimal unbalanced operation, it is important to connect both - and shield together directly on the D-sub plug, not at the other end of the harness.

Note that while the Model 76's electronically balanced output circuits are capable of driving loads of 600 ohms or greater the output level will drop slightly as the load impedance approaches 600 ohms. A 0.5 dB difference in output level can be expected as the load impedance changes from 10 k ohms to 600 ohms.

The wiring scheme used by the D-subminiature connector complies with that made popular by TASCAM® with their DA-88® product. A wiring assembly prepared for the Model 76's monitor outputs is identical to that of a DA-88-style output assembly. Please refer to Figure 4 for the

| Connections | Signal High (+) | Signal Low (-) | Shield |
|--------------|-----------------|----------------|--------|
| Surround L | 24 | 12 | 25 |
| Surround R | 10 | 23 | 11 |
| Surround C | 21 | 9 | 22 |
| Surround LFE | 7 | 20 | 8 |
| Surround LS | 18 | 6 | 19 |
| Surround RS | 4 | 17 | 5 |
| Stereo L | 15 | 3 | 16 |
| Stereo R | 1 | 14 | 2 |

Notes: 1) Connector type on Model 76 is 25-pin D-subminiature female. Installer must provide plug (male). Connector uses 4-40 threaded inserts for locking with mating plug.

2) Wiring scheme follows TASCAM DA-88 convention. Standard DA-88-type wiring harnesses are directly compatible, with the exception of 4-40 screw threads being required.

Figure 4. Connections for Analog Monitor Outputs

exact connection details. Note that unlike a DA-88-style assembly, the Model 76's D-sub connector uses 4-40 threads. This complies with the original design standard for D-subminiature connectors.

Remote Control Inputs

Support is provided for two remote control input functions: remote mute all and remote dim. The inputs use logic gates, "pulled up" to +5 volts DC by way of resistors, which are active whenever they are brought to their logic low state. Inputs of this type are commonly referred to as GPI inputs. While the input circuitry is protected from over-current and static (ESD) discharge, care should be taken to prevent nasty signals from reaching them. The inputs are active only when held in the low state; they can't be configured to change state ("latch") in response to a logic pulse.

A 9-pin female D-subminiature connector is used to interface with the remote control

| Signal | Pin | Direction |
|---------------------|-----|-----------|
| RS-485 Data+ | 7 | Input |
| RS-485 Data- | 2 | Input |
| Data Shield | 1 | Shield |
| Remote Mute All | 5 | Input |
| Remote Dim | 6 | Input |
| Remote Spare 1 | 8 | Input |
| Remote Spare 2 | 9 | Input |
| Remote Input Common | 4 | Common |

Note: Connector type on Model 76 is 9-pin D-subminiature female. Connector uses 4-40 threaded inserts for locking with mating plug.

Figure 5. Connector Pin Out for Remote Control Inputs (RS-485 connections not used)

inputs. This connector, labeled RS-485/Remote Control Inputs, is located on the back panel of the Model 76. Refer to Figure 5 for the exact connection details. Note that pin 4 (remote input common) connects to the Model 76's internal circuit common connection as well as the Model 76's chassis and mains earth connections. Figure 5 also shows two spare remote control inputs (pins 8 and 9). These are provided for future applications and should remain unconnected. This connector also allows access to an RS-485 data interface. This interface is not supported in the Model 76 and, as such, pins 7 and 2 should remain unterminated.

Connecting the Model 76 to the Model 77

A 9-pin female D-subminiature connector, labeled To/From Control Console, is provided on the back panel of the Model 76 Central Controller. This is used to interface the unit with a Model 77 Control Console. A 9-pin female D-sub connector, labeled To/From Central Controller, is provided on the back panel of the Model 77 Control

Console. A cable with 9-pin male D-sub connectors on each end is used to interconnect the Model 76 with the Model 77. A 20-foot (6.1-meter) cable is included in the shipping carton. The cable implements all nine connector pins in a one-to-one manner.

Should an interconnecting cable of a different length be required there's no problem for one to be fabricated and used. While it can be wired in a one-to-one fashion covering all nine pins, a minimum of only four connections are required: pin 1 (data+), pin 6 (data-), pin 4 (DC+), and pin 9 (DC-). The Model 76's connector pin-out scheme was designed to allow creation of an interconnecting cable which uses commonly available 2-pair audio cable. This cable, consisting of two twisted pairs each with an individual shield, is typically sleek, flexible, and available in many colors. One pair and shield can be used for the data connections while the other pair and shield can be used for the DC connections. This implementation has the advantages of providing a shield for the data path and a more robust common connection (two conductors including the shield) for the DC power circuit. Refer to Figure 6 for details.

| Signal | Pin | Direction |
|-----------------|-----|------------------|
| Data+ | 1 | To/From Model 77 |
| Data- | 6 | To/From Model 77 |
| Data Shield | 2 | To/From Model 77 |
| DC+ | 4 | To Model 77 |
| DC- | 9 | To Model 77 |
| DC Power Shield | 5 | To/From Model 77 |

Note: Connector type on Model 76 is 9-pin D-subminiature female. Connector uses 4-40 threaded inserts for locking with mating plug.

Figure 6. Connections between Model 76 and Model 77

A few simple calculations are required to determine the maximum cable length when connecting a Model 77 to a Model 76. The differential transmission scheme used by the system's RS-485 interface makes an interconnection in excess of 1000 feet (300+ meters) easily possible. The limiting factor is typically the ability of the wiring to pass the DC power supplied by the Model 76 to the Model 77. The Model 76 supplies 12 volt DC nominal with a maximum current of 200 milliamperes. The Model 77 requires a minimum of 9 volts DC, 100 milliamperes maximum for correct operation. (The voltage must be measured directly at the Model 77's 9-pin connector.) So the maximum interconnecting cable length is directly related to the resistive voltage losses associated with the two DC-carrying conductors. As the Model 76 supplies 12 volts and the Model 77 requires 9 volts minimum, this directly leads to a 3 volt DC maximum drop due to the interconnecting cable. Using Ohm's law it's quite easy to determine whether the selected cable will support the desired interconnection length. Calculate the voltage drop by multiplying the total resistance (in ohms) of the proposed cable by 0.01 (the square of the Model 77's maximum required current). Remember to include the resistance in both the DC+ and DC- wires in the figure for the total resistance.

AC Mains Power

The Model 76 is internally configured to operate from nominal 100, 120, or 220/240 volts, 50/60 Hz. Units shipped to North America are factory selected for 120 volt operation. Units bound for Japan are generally selected for 100 volts while our friends "down under" and in Europe receive units set for 220/240 volts. Before connecting the Model 76 to AC mains power, check to be

certain that it is configured to match the local mains voltage. Look on the back panel (adjacent to the power entry connector) for an indication of the factory-configured voltage. Note that an incorrect configuration could prevent operation or cause damage to the unit. Should it be necessary to change the unit's operating voltage it must be performed only at the factory, or by a factory-authorized service technician.

The Model 76 uses an IEC-standard C14 inlet connector to mate with the AC mains cord. The AC mains cord should have a C13 socket affixed with the wire colors conforming to the internationally recognized CEE color code:

| <u>Connection</u> | <u>Wire Color</u> |
|----------------------|-------------------|
| Neutral (N) | Light Blue |
| Line (L) | Brown |
| Protective Earth (E) | Green/Yellow |

Safety Warning: The Model 76 does not contain an AC mains disconnect switch. As such, the AC mains cord plug serves as the disconnection device. Safety considerations require that the plug and associated outlet be easily accessible to allow rapid disconnection of AC mains power should it prove necessary.

As soon as AC mains power is applied, the Model 76 Central Controller's power LED will light steadily. The control console data activity LED may also light. The one or more connected Model 77 Control Consoles will go through a power-up sequence, lighting each LED in succession. Using its 4-digit display, each Model 77 will also momentarily display its address, its software version, and the software version of the associated Model 76.

Advanced Installation

Additional Model 77 Control Consoles

Some installations will benefit from the Model 76's ability to be controlled by up to four Model 77 Control Consoles. In this section details on how to connect additional Model 77 units will be reviewed. While control of one Model 76 by up to four Model 77 units is fully supported, one limitation does exist. A Model 76 Central Controller is capable of providing DC power for only one or two Model 77 units. Connecting a third or fourth Model 77 requires use of a separate source of 12 volt DC power. As each Model 77 unit requires a maximum current of only 100 milliamperes, obtaining an external power supply should not prove to be an issue. Many low-cost external "wall wart" 12 volt DC power supplies are available that will be suitable to the task. For best operation they should be a "switch-mode" type with a filtered and regulated output.

As covered in a previous section of this user guide, a 9-pin female D-subminiature connector, labeled To/From Control Console, is provided on the back panel of the Model 76 Central Controller. This is provided to interface the Model 76 with up to four Model 77 Control Consoles. A 9-pin D-sub connector, labeled To/From Central Controller, is provided on the back panel of each Model 77 Control Console. A cable with 9-pin male D-sub connectors on each end is used to interconnect each Model 77 with the Model 76. A 20-foot (6.1-meter) cable is included in the main shipping carton as well as each "solo" Model 77.

These cables implement all nine connector pins in a one-to-one manner.

When connecting one or two Model 77 units to a Model 76 all nine pins of the interconnecting cables can be connected in parallel (“multed”). This will connect the data signals between the units and route the Model 76’s 12 volt DC power source to both Model 77 units. A basic cable implementation would have pin 1 (data+), pin 6 (data–), pin 4 (DC+), and pin 9 (DC–) connected. Connecting to a third and fourth Model 77 requires that only pin 1 (data+) and pin 6 (data–) be connected from the Model 76 to the third and fourth Model 77 units. (This will connect the “data bus” from the Model 76 to all the Model 77 Control Consoles.) An external 12 volt DC source must provide power to the third and fourth Model 77. This power source, capable of supplying a minimum of 200 milliamperes of current (100 milliamperes per Model 77), needs to connect to pin 4 (DC+) and pin 9 (DC–) on the third and fourth unit.

Previous paragraphs of this user guide discussed the Model 76 to Model 77 cable length issues. Please review that information prior to creating the interconnection scheme to be used for installing multiple Model 77 units.

Configuration

After the physical installation has been completed it’s important that the system’s configuration options be carefully reviewed. In most cases one or more of the operating parameters will need to be revised to meet the needs of a specific installation. Many of the parameters will impact the signal flow in to and out of the Model 76 Central Controller. Other parameters affect how the

one or more Model 77 Control Consoles will display status conditions and respond to user commands.

Configurable Parameters

Many StudioComm functions can be configured to meet the exact needs of an installation. The Model 77 Control Console is used to display and select the desired system configuration. Here’s an overview of what can be configured:

- Model 77 Device Address
- Channel Mute/Solo Function
- Stereo Output
- Digital Input Reference Level
- Monitor Output Nominal Level
- Reference Level
- Overall Display Mode
- Reference Level in dB SPL
- Auto Reference Level Off
- Dim Level
- Remote Inputs
- LFE Downmix
- Channel Pop Solo Mode Offset Levels

The configuration diagrams, located at the end of this section, give details on setting each parameter. An overview of each configurable parameter is provided in the following paragraphs.

Entering and Exiting the Configuration Mode

A small button is located on the back of each Model 77 Control Console, adjacent to the 9-pin D-sub connector. Pressing and holding this button for two seconds places

both the Model 76 and all the connected Model 77 units into the configuration mode. The Model 76 will immediately mute the analog outputs as a protection measure. In the configuration mode the Model 77's array of buttons and LEDs no longer perform their normal functions, instead allowing you to observe and change many of the operating parameters. The mute and solo LEDs, associated with the channel mute/solo mode section, will light alternately to indicate that the configuration mode is active.

To leave the configuration mode and return the Model 77 units to normal operation once again press and hold the configure button for two seconds. Note that configuration changes are stored in nonvolatile memory only after the configuration mode has been exited.

Our apologies to those of you who find the configure button a pain to use, but it's supposed to be that way! Seriously, the top of the button is slightly recessed from the back panel, making it harder to accidentally activate. We didn't want normal operation to cease because someone pushed the Model 77 into a "rats nest" of schedules, magazines, or burrito wrappers! But a firm press with the fleshy part of an index finger should do the trick.

There is no problem frequently "tweaking" the system's operating parameters to achieve the desired performance. The configuration data is stored in nonvolatile memory, which is rated for thousands of read and write cycles and a retention time in tens of years. Note that memory integrated circuits are located in both the Model 76 Central Controller and the Model 77 Control Consoles. Only the individual

device address is stored in each Model 77. All other configuration parameters are stored in the Model 76.

Model 77 Device Address

A unique device address must be assigned to each Model 77 that is connected to a Model 76. The choices are A1, A2, A3, or A4, with the default address being A1. As most installations will find only one Model 77 utilized, its default setting is appropriate. For installations that use a second, third, or fourth Model 77 each unit must be configured with a unique device address. Problems will occur if more than one unit has the same address! It's important to highlight the fact that the device address is the only setting that must be done on each individual Model 77 unit. All other settings can be made on any one of the connected Model 77 units.

Channel Mute/Solo Function

The action of the channel mute/solo function can be configured. The default selection is for the mute/solo action to take place post (after) the downmix functions. Alternately, the function can be selected such that mute or solo activity will be pre (before) the downmix functions.

Stereo Output

In addition to a 6-channel surround monitor output, a separate 2-channel stereo output is also provided. By default the stereo output can be enabled by an operator. In applications where stereo monitor loudspeakers are not connected to the stereo output, the stereo output can be disabled. This can minimize confusion, preventing an operator from attempting to select the stereo output.

Digital Input Reference Level

Configuring the digital input reference level to match the sources associated with a specific installation is an important step toward achieving optimal audio performance. This ensures that the Model 76's digital audio receiver integrated circuits are configured to match the digital input source's "0 VU" or average point. The digital input reference level can be selected from four choices: -20.0, -18.0, -16.0, and -14.0 dBFS. The Society of Motion Picture and Television Engineers (SMPTE) recommends a reference level of -20 dBFS, a value which is also extensively used in professional audio applications. The recommended digital reference level for PAL broadcast applications is -18 dBFS. The other two levels were included because... well, we can't remember why! But it seemed like a good idea at the time. If you end up using the -16.0 or -14.0 dBFS settings please let us know why and we'll add that information to the next version of this user guide!

Monitor Output Nominal Level

The nominal level of the surround (5.1) and stereo output channels is configured, as a group, matching the requirements of an installation. This setting defines the analog output level when a digital input source, at its reference level, is connected and the monitor output level is at its maximum. The choices are 0.0 or +4.0 dBu. Most applications will find the +4.0 dBu setting correct as it meets the dominant worldwide audio standards. For broadcast applications that follow the PAL standards the 0.0 dBu setting may be appropriate.

While sometimes not fully understood, using the term dBu is more in line with

contemporary audio applications than the outdated dBm and the "semi-pro" dBV references; dBu refers to audio levels without regard to their load impedance, typical of situations where an output has a low source impedance and is connected to a high-impedance input. An analog audio signal with a level of +4 dBu has an RMS level of 1.228 volts. A 0 dBu signal has an RMS level of 0.775 volts.

A final review of the two previously selected settings might now be in order. The most common input and output combination will have a digital input reference level of -20.0 dBFS and a monitor output nominal level of +4.0 dBu. For PAL broadcast applications a setting of -18.0 dBFS for the digital input and 0.0 dBu for the analog outputs would be typical.

Reference Level

For audio-with-picture applications it's often beneficial for monitoring to be done in reference to a known loudspeaker level. This is often referred to as "mixing to 85 dB" on the monitors. The StudioComm system allows a precise monitor output level to be stored, and then enabled by pressing the Model 77 button labeled Reference Level. Setting the reference level is very simple but care is required:

1. Set up a precision sound pressure level (SPL) measuring device at the desired listening location.
2. Place the StudioComm system in the normal operating mode, not the configuration mode. Be certain that the dim, mute all, reference level, and downmix functions are not active. The remote mute all or remote dim functions must not be active.

3. Use the Model 77 Control Console to select the input source that contains the desired reference signal source, e.g., pink noise.
4. Observing the SPL meter, adjust the Model 77's rotary level control until the desired reference monitor system level has been reached.
5. Being careful not to disturb the position of the rotary level control, enter the configuration mode by pressing and holding the configuration button located on the Model 77's back panel.
6. Once the configuration mode has been entered, the monitor outputs will mute. Press and hold the reference button; its associated LED will begin to flash. After five seconds the LED will light steadily to indicate that a "snapshot" of the new reference level has been taken. The Model 77's numeric display will then show the value of the new reference level. The value shown will always be a negative number as it's always a value less than the maximum output level. The reference level button can now be released.
7. To complete the process the configuration mode must be exited. This is performed by again pressing and holding the configure button for two seconds. The new reference level is now stored in the Model 76's nonvolatile memory. Only by repeating the entire procedure can the value be changed.

Once the configuration mode has been exited, the monitor outputs will again become active. Confirm that the correct level has been stored by pressing the reference level button. The SPL meter should display the desired level. If not, repeat the calibration procedure to achieve the desired goal.

You might wonder why you have to press and hold the reference level button for five seconds before the selected value is recognized. This is provided specifically so that unauthorized users won't accidentally change the reference level while they experiment with the configuration mode. Only if you know the "secret" will you be able to store a new value.

Overall Display Mode

The Model 77's 4-digit numeric display can be configured to display the output level in either an attenuation mode or an SPL mode. In the attenuation mode the output level is shown as a reduction in value relative to the maximum output level. When the rotary control is used to set the output level to its maximum the display will show 0.0. As the rotary control is moved in the counterclockwise direction the display will show negative values, reaching approximately -69.5 dB before the full mute function automatically mutes the outputs.

In the SPL mode the display can be configured to allow the output level to be presented to users in terms of the actual sound pressure level (SPL). Used in conjunction with the reference level in dB SPL configuration and the stored reference level, SPL mode allows a user to see a visual representation of the SPL level that is present in the listening environment. While it takes a little more care to correctly implement the SPL display mode, it can offer an enhanced experience for StudioComm users.

Reference Level in dB SPL

The reference level in dB SPL configuration allows a specific SPL value to be associated with the stored reference level value. In this way whenever the monitor output is

at the reference level, either through activating the reference level function or manually adjusting the rotary level control, the Model 77's display will show the configured SPL level. Whenever the monitor output is not at the reference value the display will show the current value, in dB, relative to the reference level. The reference level in dB SPL can be configured over a range of 70.0 to 100.0 dB in one-dB steps. In many applications a value of 85 would be appropriate, reflecting the widely used audio-for-picture 85 dB monitoring reference level. (Typically this 85 dB is really 85 dBC, indicating that a C-weighting filter has been applied to the measurement.) Other common reference SPL values, such as 82 and 87, are well within the allowable range.

Auto Reference Level Off

When auto reference level off is enabled, the function automatically turns the reference level function off if a change is made to the rotary level control while the reference level function is active.

Dim Level

The dim function is used to reduce the monitor output level by a preset amount. The reduction is in dB relative to the monitor output's current level. There are four dim level values available: -10.0, -15.0, -20.0, and -25.0 dB.

Remote Mute All

Two configuration choices are associated with the remote mute all function: disabled and enabled. To utilize the remote mute all function simply requires you to select the enabled setting.

Remote Dim

Two configuration choices are associated with the remote dim function: disabled and enabled. To utilize the remote dim function simply configure it for enabled.

LFE Downmix

When the surround to stereo downmix mode is active the LFE channel typically mutes. When the LFE downmix mode is configured for enabled, the LFE channel is attenuated by 3 dB and mixed into the left and right channels. This is provided for special applications and won't typically be used.

Channel Pop Solo Mode Offset Levels

Two parameters can be configured that set how the channel pop solo function will impact audio levels. The up offset level sets the amount of increase (gain) that a channel will experience when it is soloed in the channel pop solo mode. The down offset level sets the amount of decrease (attenuation) the non-soloed channels experience when a channel is active in the channel pop solo mode.

Configuration—Entering and Exiting Configuration Mode

 Press and hold the configuration button for 2 seconds to enter or exit the configuration mode.

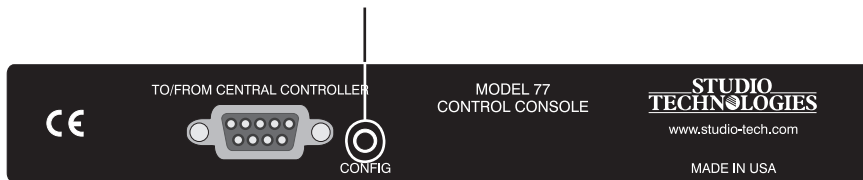

These LEDs will light alternately when configuration mode is active.

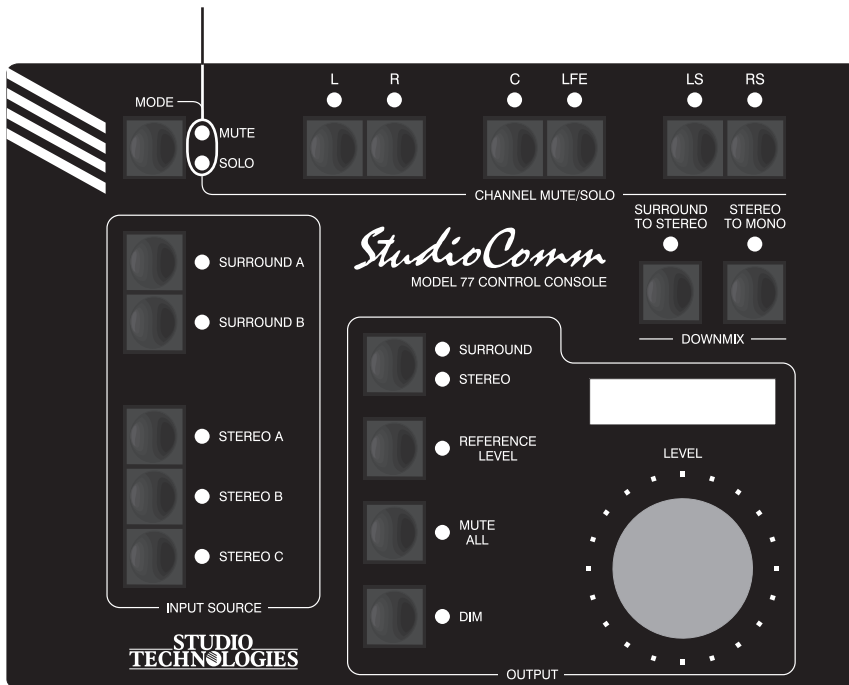

Configuration—Model 77 Device Address, Channel Mute/Solo Function, and Stereo Output

 Press and hold the Mute/Solo button to display and configure the Model 77's device address, channel mute/solo function, and stereo output function.

When the Mode button is pressed, use the Channel Mute/Solo L and R buttons to select the channel mute/solo function. Use the buttons to change the configuration. LED L lit means pre downmix channel mute/solo; LED R lit means post downmix channel mute/solo.

When the Mode button is pressed, these LEDs display the status of the stereo output function. When LED Surround is lit the stereo output function cannot be enabled. When LED Stereo is lit the stereo output function can be enabled. Use the button to change the configuration.

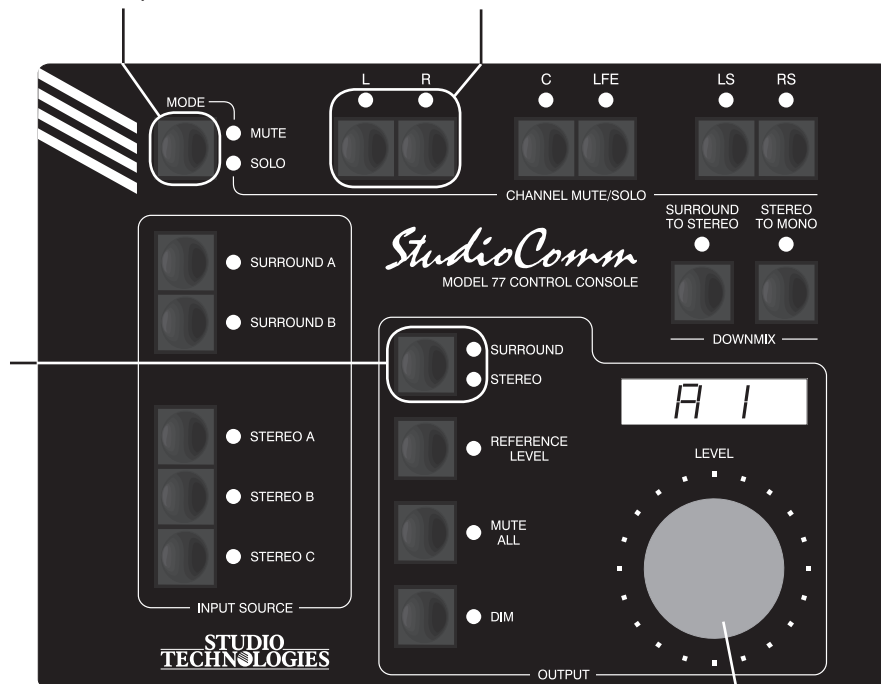

When the mode button is pressed, use the Level control to change this specific Model 77's device address. Address can be either A1, A2, A3, or A4.

Default: Device address A1.
Post downmix channel mute/solo.
Stereo output can be enabled.

Note: The Model 77's device address is the only parameter stored in the Model 77. All other parameters are stored in the Model 76.

Configuration—Digital Input Reference Level and Monitor Output Nominal Level

When the Stereo to Mono button is pressed, use the Channel Mute/Solo L and R buttons to select the monitor output nominal level. Use the buttons to change the configuration. LED L lit means nominal level is 0.0 dBu; LED R lit means nominal level is +4.0 dBu.

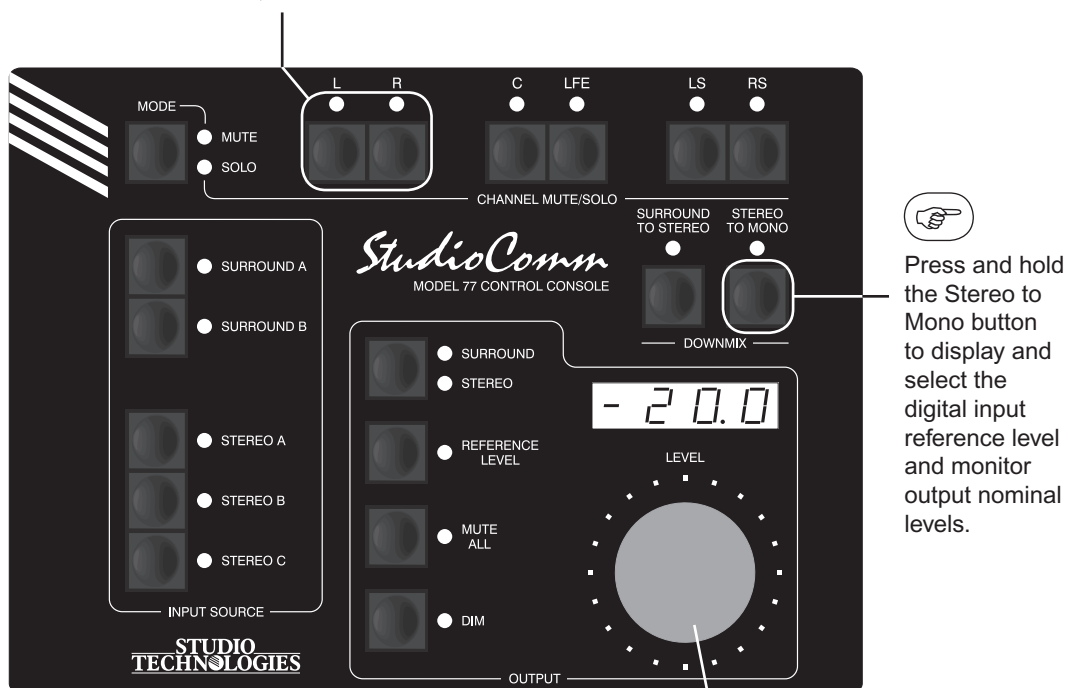

When the Stereo to Mono button is pressed, use the Level control to adjust the digital input reference level. Available levels are -20.0 dBFS, -18.0 dBFS, -16.0 dBFS, and -14.0 dBFS.

Default: -20.0 dBFS digital input reference level.
+4.0 dBu monitor output nominal level.

Configuration—Reference Level

-  Press and hold the Reference Level button for 5 seconds to take a “snapshot” of the current monitor output level at the time configuration mode was entered. The Reference Level LED will flash when the button is initially pressed and then light steadily when the “snapshot” has been taken.

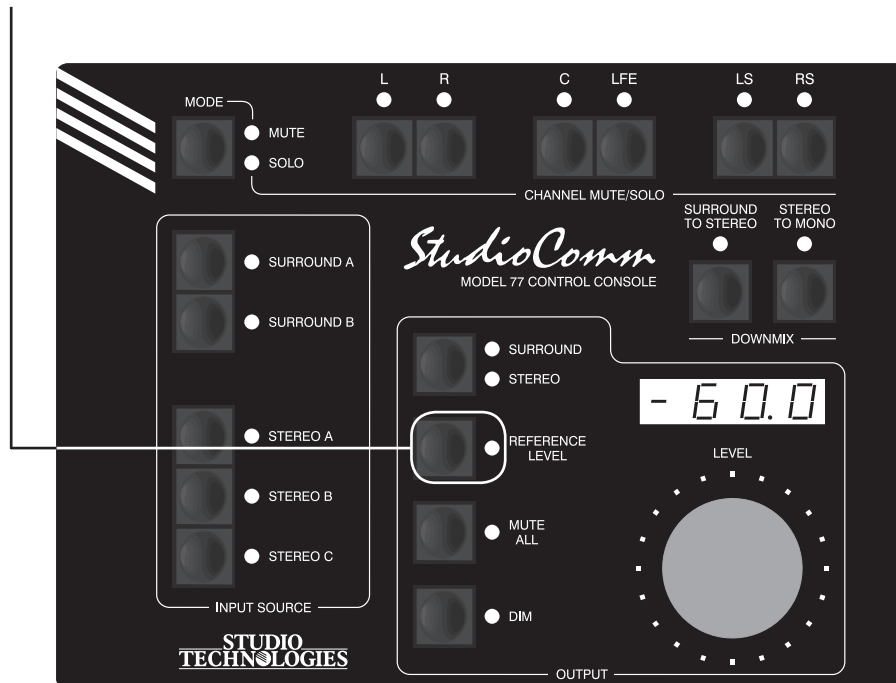

Default: Reference level set for -60.0 dB monitor output level.

Note: The 5-second delay is a safety feature ensuring that the reference level will not be accidentally changed. To permanently store the new value, you must still exit the configuration mode.

Configuration—Overall Display Mode, Reference Level in dB SPL, and Auto Reference Level Off

When the Mute All button is pressed, use the Channel Mute/Solo L and R buttons to select the overall display mode. LED L lit means attenuation mode is selected; LED R lit means SPL mode is selected. Use the buttons to change the configuration.

When the Mute All button is pressed, use the Reference Level button to enable or disable auto reference level off. When the Reference Level LED is lit auto reference level off is enabled.

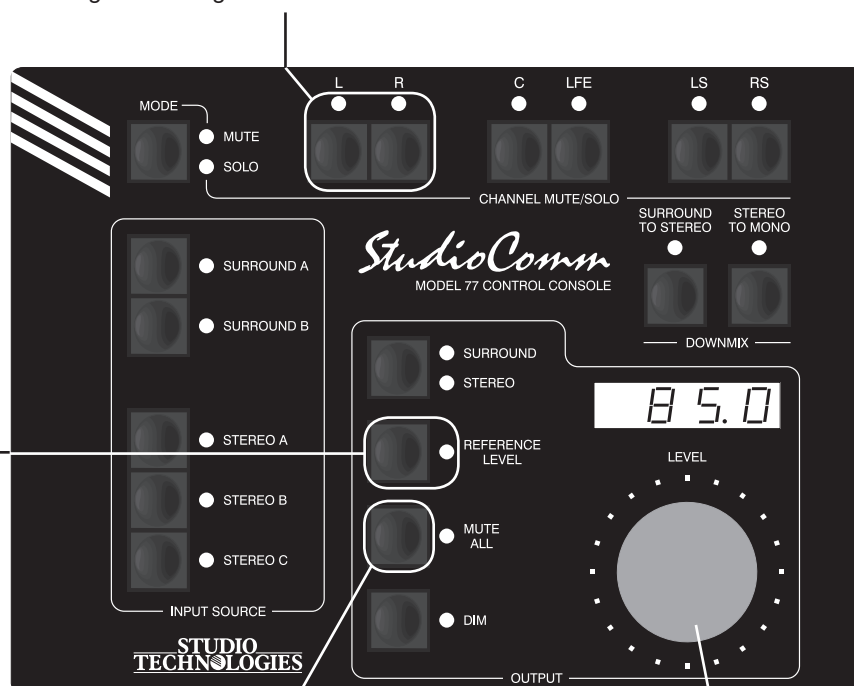

Press and hold the Mute All button to display and set the overall display mode, the reference level in dB SPL, and auto reference level off.

When the Mute All button is pressed, use the Level control to adjust the reference level in dB SPL.

Default: Attenuation display mode selected.
85.0 dB SPL reference level.
Auto ref level off disabled.

Configuration—Dim Level, Remote Mute All, and Remote Dim

This LED displays the configuration of remote mute all. LED not lit means remote mute all is disabled; LED lit means enabled. Use the button to change the configuration.

This LED displays the configuration of remote dim. LED not lit means remote dim is disabled; LED lit means enabled. Use the button to change the configuration.

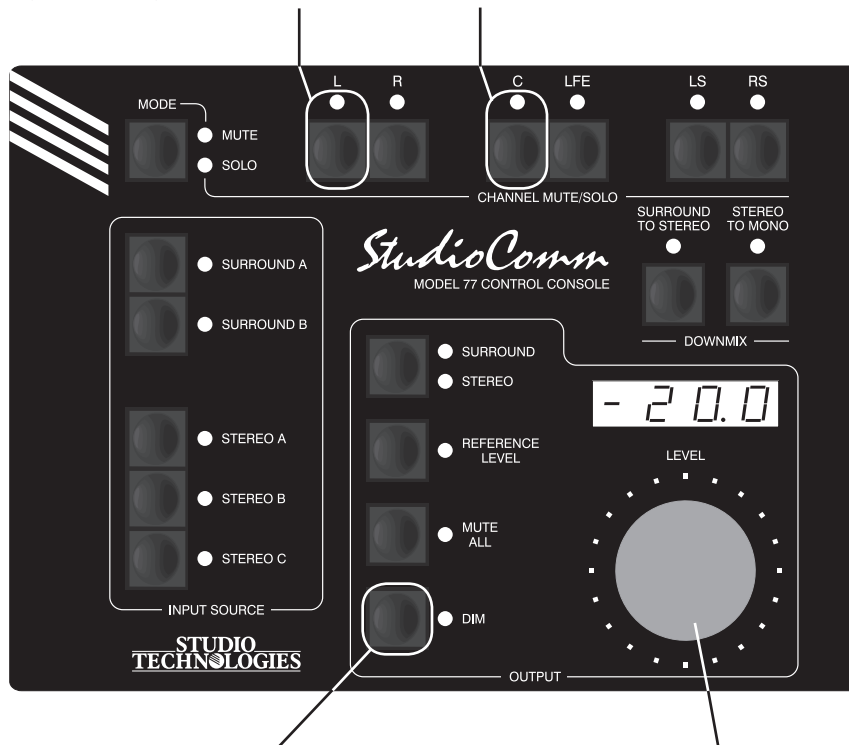

 Press and hold the Dim button to display and select the dim level, remote mute all, and remote dim input configurations.

When the Dim button is pressed, the 4-digit display shows the currently selected dim level. Use the Level control to adjust the dim level. Available dim levels are -10.0 dB, -15.0 dB, -20.0 dB, and -25.0 dB.

Default: -20.0 dB dim level.
Remote mute all disabled.
Remote dim disabled.

Configuration—LFE Downmix

This LED displays the configuration of the LFE downmix mode. LED not lit means LFE downmix mode is disabled; LED lit means enabled. Use the button to change the configuration.

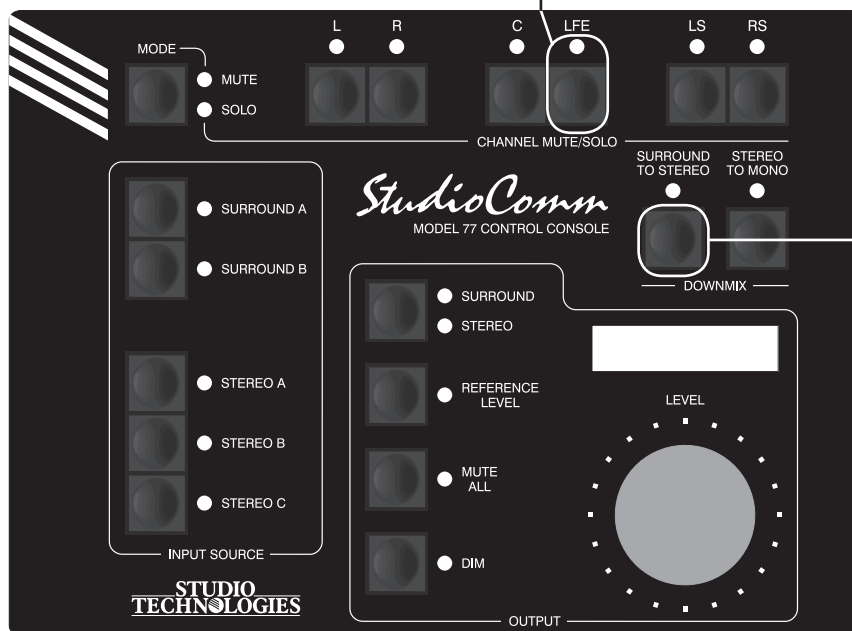

Press and hold the Surround to Stereo button to display and set the LFE downmix mode.

Default: LFE downmix disabled.

Configuration—Channel Pop Solo Mode Offset Levels



Press and hold the Surround A button to display and select the channel pop solo up offset level.



Press and hold the Surround B button to display and select the channel pop solo down offset level.

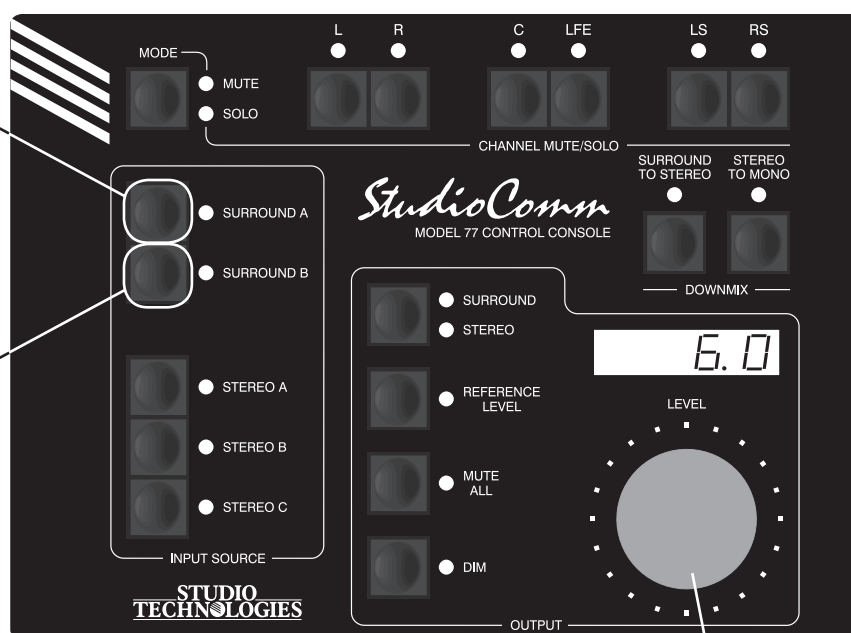

When the Surround A button is pressed, use the level control to adjust the channel pop solo up offset level. The range is 0.0 to 12.0 in 0.5 dB steps.

When the Surround B button is pressed, use the level control to adjust the channel pop solo down offset level. The range is -0.0 to -12.0 in 0.5 dB steps and full mute. Full mute is selected by adjusting the level control past -12.0, at which point the display will show '---'.

Default: 6.0 dB channel pop solo up offset level.
-6.0 dB channel pop solo down offset level.

Configuration—Restore Factory Defaults



Press and hold both the Surround/Stereo and Dim buttons for 5 seconds to restore Model 77 factory defaults. Once defaults have been restored, the associated LEDs will light. After the buttons are released, configuration mode will be exited and normal operation will resume.

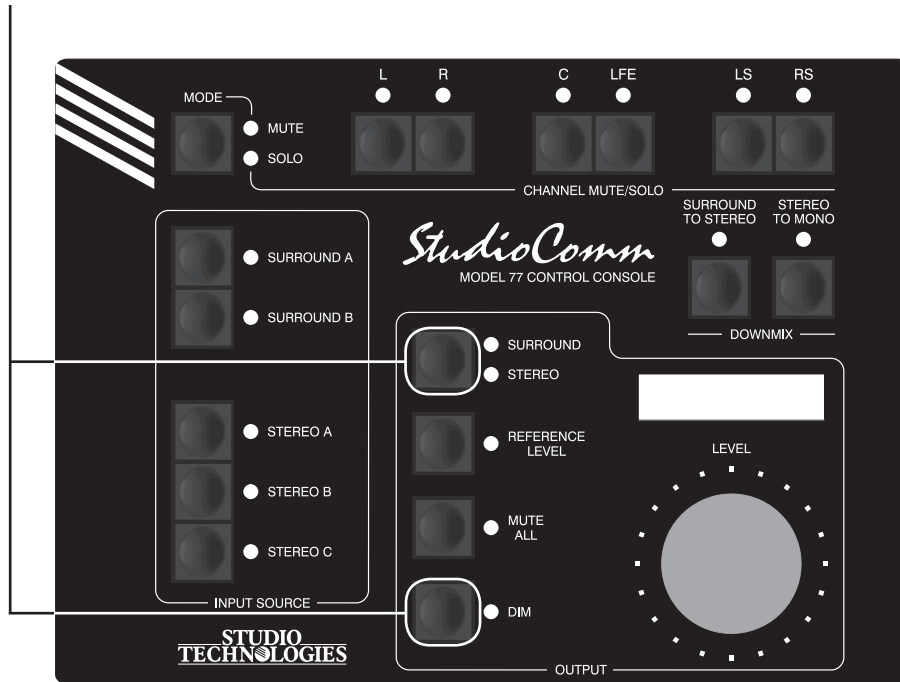

Factory Defaults:

- Device address A1.
- Post downmix channel mute/solo.
- Stereo output can be enabled.
- 20.0 dBFS digital input reference level.
- +4.0 dBu monitor output nominal level.
- Reference level is set for -60.0 dB monitor output level.
- Attenuation display mode selected.
- 85.0 dB SPL reference level.
- Auto reference level off disabled.
- 20.0 dB dim level.
- Remote mute all disabled.
- Remote dim disabled.
- LFE downmix disabled.
- 6.0 dB channel pop solo up offset level.
- 6.0 dB channel pop solo down offset level.

Warning: Each Model 77 unit must have a unique address. Restoring factory defaults will reset only this specific Model 77 to device address A1. If another connected unit is already configured for address A1, normal system operation will stop.

Note: The 5-second button-press delay is a safety feature ensuring that the factory defaults will not be accidentally restored.

Operation

Now that you've installed and configured the system, you're ready to go. You should find operation very easy. However, taking time to study this section of the guide may prove valuable.

Upon power up the system will return to the last operating condition, including all selected sources, downmix modes, etc. As a precaution, however, the monitor output level will always return to its minimum value. The rotary level control or the reference level button must then be used to return the system to the desired monitor output level.

Model 76 Central Controller

The Model 76's front panel contains two LEDs. The power LED should be lit whenever AC mains power is connected. The data LED will light steadily whenever the Model 76 is communicating correctly with the one or more connected Model 77 units. The data LED will remain off during the system power-up process, something that typically takes several seconds to complete.

Model 77 Control Console

StudioComm for Surround operation is controlled using Model 77 Control Consoles and, if connected, the remote control inputs. In most installations only one Model 77 will be present but, as previously discussed, up to four can be connected to one Model 76. To make things easy to describe, we've divided the operator functions into six main groups: input source selection, downmix, monitor output general functions, channel mute/solo, display and display mode, and remote control inputs.

Any change made to any one Model 77 will be reflected in the status LEDs and displays on all the connected units. And note that all Model 77 units function simultaneously—there is no priority of one unit over the others.

Input Source Selection

To select an input source press one of the five input source buttons. The corresponding LED will light to indicate that the input has been selected. Typically, only one source will be selected for monitoring at any one time. However, input stereo C can be selected by itself, or mixed (summed) with one of the other four inputs. To accomplish this selection of two inputs is easy: simply press and hold input stereo C then press the button associated with the other desired input source. The two corresponding LEDs will light. Alternately, press and hold the first desired input (other than input stereo C) and then press the input stereo C button.

Downmix

Two downmix functions allow users to perform "real-world" audio format compatibility checks. One function allows a surround (5.1) signal to be "folded down" (mixed) to stereo (2-channels). The other allows a stereo (2-channel) signal to be converted to mono. Using the downmix functions simply requires pressing the desired button. The buttons are set to always "latch" the functions on and off. An LED is located above to each button and lights whenever its respective function is active. Please refer to the Technical Notes section of this guide for a detailed description on how the downmix functions perform their tasks.

Surround to Stereo

When the surround to stereo downmix function is enabled the LS, RS, and C channels associated with a surround signal are combined (“folded down”) with the L and R signals to create a 2-channel stereo (left and right) signal. The resulting stereo signal, sometimes known as LoRo, is routed to the L and R monitor output channel. The C, LFE, LS, and RS monitor output channels are muted. By utilizing this downmix function phase relationships and inter-channel level issues can be quickly observed.

Note that a configuration setting allows the LFE channel to be routed to both the L and R outputs when surround to stereo downmix is active. As such, if this configuration is selected the LFE channel won't mute when the surround to stereo downmix function is active.

Stereo to Mono

The stereo to mono downmix function combines the left and right audio channels to create a single-channel monaural signal. This signal is sent out the C (center) monitor output channel while the L, R, LS, RS, and LFE monitor output channels are muted.

Note that when a surround input source is selected for monitoring, the surround to stereo downmix function will automatically enable whenever the stereo to mono downmix function is enabled. This ensures that an operator will hear a mono signal created by folding down all channels associated with the selected surround input.

The Model 77 associates the state of the downmix functions with the currently selected input. For example, if surround B is the selected input source and surround to

stereo downmix is enabled, the condition will be “remembered” when switching to a stereo input source. Upon returning to surround B as the input source, the surround to stereo downmix function will again become active.

Note that a specific downmix function can only be enabled when it is applicable for the currently selected input source. This means that the surround to stereo downmix function can only be enabled when a surround (5.1) input source is selected.

Bandpass Filter for Stereo to Mono Downmix

A bandpass filter can be inserted into the path of the stereo to mono downmix signal. This allows the simulation of the response of a loudspeaker associated with an inexpensive monaural television or portable radio. This special feature has been included to assist an operator in determining compatibility with “real-world” playback environments. The filter passes signals in the range of 100 Hz to 5 kHz, while rejecting those above and below. For a detailed technical description of the bandpass filter please refer to the Technical Notes section of this guide.

To enable the bandpass filter feature requires knowing a “secret” button push method. But it's not much of a secret, as you simply press and hold the stereo to mono downmix button for two seconds to enable the function. From that point forward, whenever the stereo to mono downmix function is enabled the bandpass filter will also be enabled. To indicate that the bandpass filter is enabled, the LED associated with the downmix mono button will flash whenever its associated function is enabled. To disable the bandpass function, press and hold the stereo to

mono downmix button for two seconds. The change will be indicated by the LED, which will now light steadily whenever the stereo to mono downmix function is enabled.

Monitor Output General Functions

Four buttons and one rotary control are associated with the monitor output functions. The buttons control operation of the surround and stereo outputs, reference level, mute all, and dim functions. The rotary level control is used to manually set the monitor output level.

Surround and Stereo Outputs

The surround/stereo function allows selection between two different loudspeaker systems. When the surround output is selected the six surround (5.1) output channels are active. The two channels associated with the stereo output are muted. When the stereo output is selected the left and right channels associated with the stereo output become active; the six channels of the surround output mute.

Remember that the Model 77 Control Console can be configured to disable the surround/stereo button. If the button is pressed and nothing happens, this must be the case!

Reference Level

The reference level button sets the monitor output level to a preset value. Technical personnel, using a sound pressure level (SPL) meter and precision signal source, should have set this level to meet the requirements of the specific monitoring environment. The LED associated with the reference level button will light whenever the function is active. Whenever the reference level mode is active the rotary level control is disabled.

The 4-digit display will indicate the reference output level. Note that the system's default reference level is -60.0 dB so "out of the box" the Model 77 will display **-60.0** when reference level mode is enabled.

The reference level LED also serves as a calibration aid. If the reference level mode is not active, whenever the monitor output level is precisely the same as that stored for the reference value the reference LED will flash.

Mute All

The mute all function is highly complicated to operate—not! Pressing the mute all button causes all monitor output channels to mute. The 4-digit display indicates the mute condition by showing four horizontal dashes. The mute all button is always set to "latch" the function on and off. The LED associated with the mute all button will light whenever mute all is active. Note that if mute all is enabled via the remote mute all function, the mute all LED will flash.

Dim

The dim function is provided for user convenience, allowing the monitor output level to be reduced by a fixed amount. The Model 77's configuration mode allows the dim level to be selected from among four choices: -10.0 , -15.0 , -20.0 , or -25.0 dB. Pressing the dim button will enable the function. The dim button is always set to "latch" the function on and off. The 4-digit display will indicate the revised monitor output level. If the "dimmed" output level is equal to or less than the minimum attenuated level, the monitor output will go into full mute and the display will show four horizontal dashes.

When dim is active the monitor output level reduction will apply no matter whether the monitor output level is being set by the rotary level control or by the reference level

button. The LED associated with the dim button will light whenever dim is active. If dim mode is enabled via the remote dim function the dim LED will flash.

It's worth using a few sentences to discuss the auto dim off function. Whenever dim is enabled due to the dim button being pressed, as well as the rotary level control being active (reference level mode is not active), changing the setting of the rotary level control will automatically turn off dim. The auto dim off function is a unique attempt at protecting the aural health of users. No longer will there be a heart-stopping blast of audio when the dim button is pressed, supposedly to enable dim, but actually turning dim off because it was already enabled. It's hard to explain unless you've experienced this in person—trust us, this situation can and does happen!

Note that the auto dim off function is not active whenever dim is enabled due to the remote dim function being active. This allows remote control equipment, such as a talkback system, to reliably dim the monitor outputs.

Rotary Level Control

The rotary level control is used to manually adjust the monitor output level. The level control provides the ability to adjust the monitor output level over a 70 dB range. Technically the rotary level control is a 24-step-per-revolution mechanical encoder. The amount of level change in dB per step ("click") will depend on how quickly the control is turned. When changed slowly, each step represents a 0.5 dB change in level. In this case, to traverse the entire level range would require rotating the control more than four full turns. But the Model 77's software detects when the control is rotated more quickly and increases the

amount of level change in dB per step. A little experimentation will allow the user to acquire a good "feel" for how best to use the control.

The reference level LED will flash when the rotary level control sets the output level to be the same as the stored reference level. Note that the rotary level control is not active when the reference level function is on and auto reference level off is off. Whenever the rotary level control is used to set the output level for minimum, the monitor output channels will automatically mute. Technically, this has the same effect as when the mute all function is active.

Channel Mute/Solo

The mute/solo mode button and the six monitor output channel buttons, along with associated LEDs, work together to provide excellent operating flexibility. Depending on the configuration of the mute/solo function, mute or solo activity will take place pre (before) or post (after) the downmix functions. When the mute/solo function has been configured to post downmix the channel pop solo mode can also be enabled.

The channel mute/solo mode button allows the operator to select between the mute and solo functions. It is also used to select which solo mode, normal or channel pop, is active. Going from mute mode to solo mode, or vice-versa, clears all active mutes or solos. Pressing the mode button twice is a legitimate means of quickly clearing muted or soloed channels.

In the mute mode, multiple channels can be muted simultaneously. A channel that is muted has its associated LED turned on. In solo mode multiple channels can be soloed simultaneously. A channel that is soloed has its associated LED flash on

and off, while the LEDs on the non-soloed channels are not lit.

The channel pop solo function is available when the mute/solo function is configured for post downmix. In this case, the system can be changed between normal solo mode and channel pop solo mode. Simply press and hold the mute/solo mode button for a few seconds until the solo LED lights in the desired manner; steady for normal solo mode and flashing for channel pop solo mode. Once the state of the LED changes (steady-to-flashing or vice-versa) the desired solo mode becomes active. The selected solo mode will be maintained even after the system is powered down and subsequently powered up.

Display and Display Mode

The Model 77's 4-digit LED display shows the output level as either the amount of attenuation or the sound pressure level (SPL). Both figures will indicate level in dB. What the digits actually represent will depend on how the Model 77 has been configured. If configured for the attenuation mode the display will show the output level as an attenuation value in reference to the maximum output. This is in the form of 0.5 db steps less than 0.0 dB. So a display of -40.5 would indicate that the output is set to be 40.5 dB below the maximum level. As the rotary level control is moved counterclockwise the output level will go down and the indicated value will get more negative.

If the Model 77 is configured to display the output level in SPL, the 4-digit display will always show the output level in positive numbers. These numbers are intended to represent the sound pressure level in dB SPL, a figure that should directly relate to the actual sound pressure level that the loudspeaker system is presenting to users.

(Typically, the level value would actually be in dBC, the C-weighted sound pressure level.) When the reference level button is enabled, or the rotary level control is set so that the reference level has been reached, the display will typically show something in the range of 82 to 87 dB. Assuming that the monitoring environment has been correctly calibrated, this would indicate that an average listening level of 85 dB, for example, had been achieved.

As has been previously discussed, the channel pop solo mode offers a unique way of sonically highlighting an individual channel. A channel selected for soloing in this mode will have its level increased while the other non-soloed channels will be reduced in level. To highlight this condition the letters POP will appear in the 4-digit display whenever a channel is actively being soloed in the channel pop solo mode. This ensures that a user will understand that the monitor outputs no longer represent the true inter-channel level relationships.

Remote Control Inputs

Two remote control signals can be connected to the StudioComm system and configured for operation. The two functions are remote mute all and remote dim. When an external signal activates remote mute all the LED on the Model 77 associated with the mute all button will flash. If mute all was already active when the remote mute all function is activated, the LED will change from being steadily lit to flashing.

When an external signal activates remote dim the LED on the Model 77 associated with the dim button will flash. If dim was already active when remote dim is activated, the LED will change from being steadily lit to flashing.

Technical Notes

Downmix

The downmix functions are implemented in the Model 76 Central Controller's hardware using analog circuitry. The surround to stereo downmix function performs this action: center (C) dropped in level by 6 dB and routed to the left (L) and right (R) monitor outputs; left surround (LS) dropped in level by 3 dB and routed to the L monitor output; right surround (RS) dropped in level by 3 dB and routed to the R monitor output; low-frequency-enhancement (LFE) input muted. A configuration choice allows the LFE channel to be dropped by 3 dB and routed to the L and R monitor outputs. This will be generally enabled only for special applications.

The stereo to mono downmix function performs this action: L dropped in level by 3 dB and routed to the C monitor output; R dropped in level by 3 dB and routed to the C monitor output; L, R, LFE, LS and RS monitor outputs mute; C input muted.

Bandpass Filter

The bandpass filter associated with the stereo to mono downmix mode is created by cascading (connecting in series) a high-pass and a low-pass active filter. Each filter is a Sallen-Key type, with a 12 dB-per-octave response. The high-pass filter has a nominal -3 dB point at 100 Hz; the low-pass at 5 kHz. For a detailed description of the filters, refer to page 7 of the Model 76 schematic diagram.

“Hot” Disconnection of Model 77 Control Consoles

There's no problem relocating a Model 77 Control Console while the StudioComm for surround system is powered up and operating. You can disconnect the 9-pin interconnecting cable from a Model 77, move the unit, and then re-connect without issue. If only one Model 77 is present, disconnecting it from the Model 76 will cause the monitor outputs to mute. No clicks, pops, or other noises will occur when the Model 77 is again connected. The Model 77 will go through its standard power-up sequence and then normal operation will resume. If more than one Model 77 is connected, disconnecting one unit won't cause any change to the system's operation. Only when there are no Model 77 units connected to a Model 76 will the outputs mute. Of course, any time a Model 77 is connected it will go through its standard power-up sequence prior to continuing with normal operation.

Monitor Output Transient Protection

The Model 76 Central Controller contains a power-up/power-down transient protection feature. This limits the chance of damage to the monitor loudspeakers during the time when AC mains voltage is connected, disconnected, or has changed significantly from nominal. A combination of hardware and software is used to monitor the internal DC power supply “rails.” Until the DC “rails” exceed their nominal operating voltage range, electromechanical relays maintain a short-circuit condition on the monitor

outputs. After the DC voltages are recognized as valid, a short delay takes place before the relays are allowed to function normally. Whenever the AC mains input drops below its nominal operating voltage range, the DC “rails” will drop and the relays will almost immediately go into their muted state. During testing it was found that upon AC mains power up the monitor outputs remained very quiet; during power down a small to moderate “tick” was the worst that was heard.

Model 76 to Model 77 Connections

Figure 6 gives a detailed description of the signals that connect the Model 76 Central Controller to the one or more Model 77 Control Consoles. The Model 76 provides a 12 volt DC, 200 milliampere maximum power source for use by one or two Model 77 units. The DC output is current-limited to minimize the chance that a short-circuit condition will damage the Model 76’s circuitry. An asynchronous, bi-directional data interface links the units. This uses an RS-485 hardware connection scheme that operates at a rate of 115.2 kbit/s and uses an 8-N-1 data format. The Model 76 communicates with each Model 77 20 times-per-second, receiving button and rotary level control information and sending LED and 4-digit display status data.

Mono-to-Center Polarity

It’s worthwhile to note that a polarity inversion takes place whenever the stereo to mono downmix function is active; the left (L) and right (R) input signals experience a 180-degree inversion in the Model 76’s combining circuitry. This should not cause a problem as monitoring audio signals over a single loudspeaker is considered polarity insensitive. Only during electrical testing would this condition be detected.

Specifications

Model 76 Central Controller

General Audio:

Frequency Response: digital inputs to monitor outputs loaded with 10 k ohms

32 to 48 kHz Sample Rate: 20 Hz-20 kHz
±0.05 dB

88.2 to 96 kHz Sample Rate: 20 Hz-40 kHz
±0.05 dB

176.4 to 192 kHz Sample Rate: 20 Hz to 40 kHz
±0.05 dB; down 0.5 dB at 80 kHz

Distortion (THD+N): 0.004%, ref 1 kHz, +4 dBu output

S/N Ratio: 86 dB, ref +4 dBu output

Dynamic Range: greater than 106 dB

Crosstalk: 104 dB at 1 kHz; 90 dB at 20 kHz,
ref -1 dBFS input

Digital Audio Inputs: 5

Configuration: organized as two surround (5.1)
and three stereo (2-channel)

Supported Sample Rates: 32, 44.1, 48, 88.2, 96,
176.4, and 192 kHz

Word Length: 24 bits maximum

Type: AES3id-2001 (SMPTE 276M)

Impedance: 75 ohms, unbalanced

Reference Level: -20.0, -18.0, -16.0, or
-14.0 dBFS, selectable

Sync Source: all inputs independently self-clocking

Monitor Outputs: 8

Configuration: organized as one surround (5.1)
and one stereo (2-channel)

Type: electronically balanced, compatible with
balanced or unbalanced loads

Nominal Level: 0.0 or +4.0 dBu, selectable

Maximum Level: +26 dBu into 600 ohms or
greater

Remote Control Inputs: 4

Functions: remote mute all, remote dim, two spare

Type: +5 V logic, activates on closure to system
common

Downmix:

Functions: surround (5.1) to stereo, stereo to
mono

Surround to Stereo: LS @ -3 dB summed with L;
RS @ -3 dB summed with R; C @ -6 dB summed
with L and R; C, LFE, LS, and RS monitor outputs
mute

Stereo to Mono: L @ -3 dB summed with R @
-3 dB to C; L, R, LS, RS, and LFE monitor outputs
mute; C input mutes

Stereo to Mono Bandpass Filter:

Response: -3 dB @ 100 Hz and 5 kHz, nominal,
12 dB/octave

Control Console Interface:

Power: 12 volts DC, 200 milliamperes maximum

Control Data Type: RS-485

Control Data Rate/Format: 115.2 kbit/s, 8-N-1

Polling Interval: 50 milliseconds

Connectors:

Digital Audio Inputs: 9, 75 ohm BNC

Monitor Outputs: 25-pin D-subminiature female

Control Console: 9-pin D-subminiature female

Remote Control Input: 9-pin D-subminiature
female

AC Mains: 3-blade, IEC 320 C14-compatible
(mates with IEC 320 C13)

AC Mains Requirement: 100, 120, or 220/240 V,
±10%, factory configured, 50/60 Hz, 30 watts
maximum

Dimensions (Overall):

19.00 inches wide (48.3 cm)

1.72 inches high (4.4 cm)

8.75 inches deep (22.2 cm)

Mounting: one space in a standard 19-inch rack

Weight: 8.8 pounds (4.0 kg)

Model 77 Control Console

Application: up to four Model 77 Control Consoles
can be connected to Model 76 Central Controller
(two can be powered by Model 76)

Power: 12 volts DC, maximum current 100
milliamperes, typically provided by Model 76
Central Controller

Control Data:

Type: RS-485

Data Rate/Format: 115.2 kbit/s, 8-N-1

Connector: 9-pin D-subminiature female

Dimensions (Overall):

7.20 inches wide (18.3 cm)

2.20 inches high (5.6 cm)

5.40 inches deep (13.7 cm)

Weight: 1.7 pounds (0.8 kg)

Specifications and information contained in this User Guide subject to change without notice.

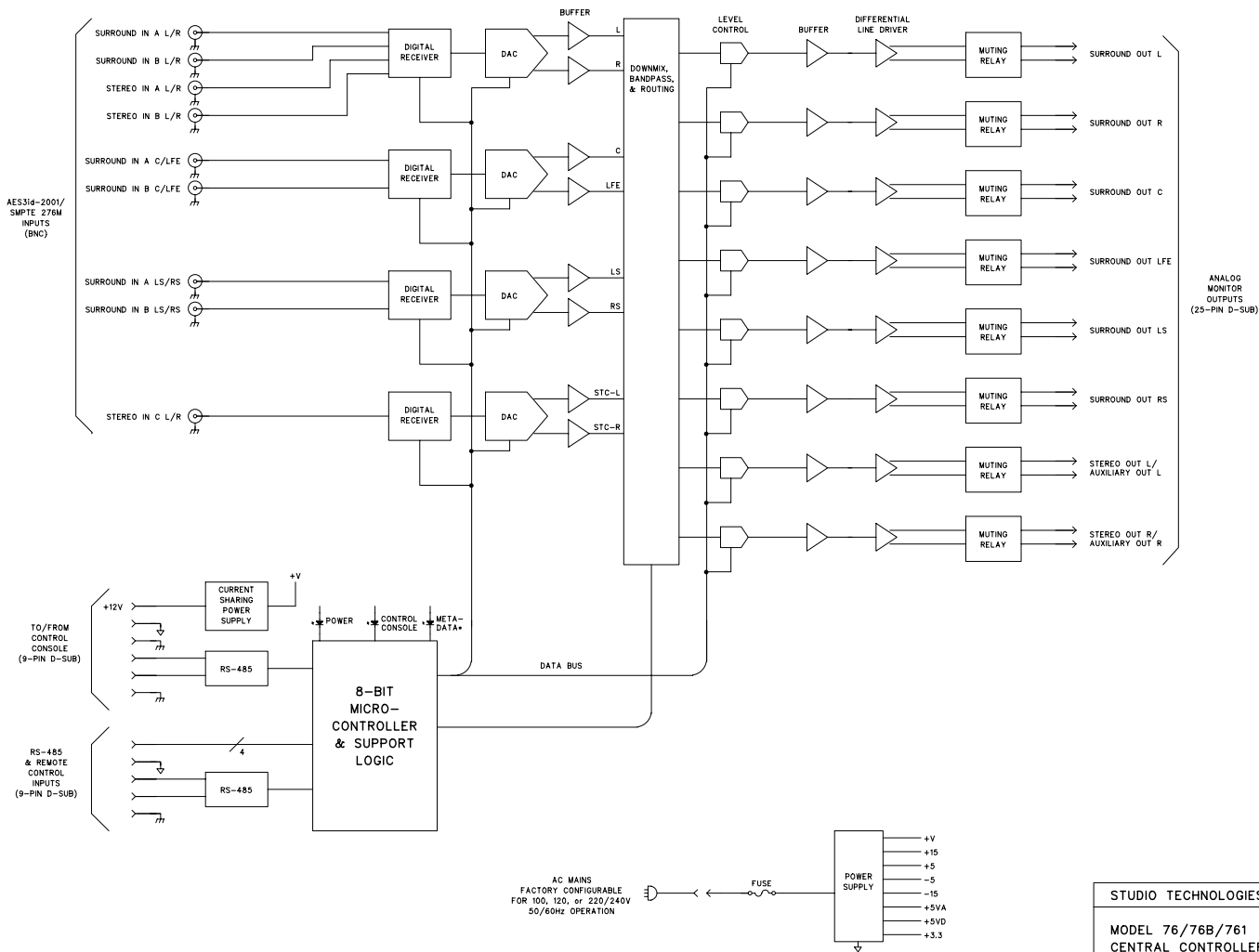

• FOR MODELS 76B AND 761 ONLY

M76BD_C

| | | |
|---|----------|----------|
| STUDIO TECHNOLOGIES, INC. | | |
| MODEL 76/76B/761 CENTRAL CONTROLLER BLOCK DIAGRAM | | |
| DRAWING NO. | DATE | PAGE |
| 31308 | 02/14/08 | 01 of 01 |

TO/FROM
CENTRAL
CONTROLLER

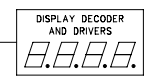
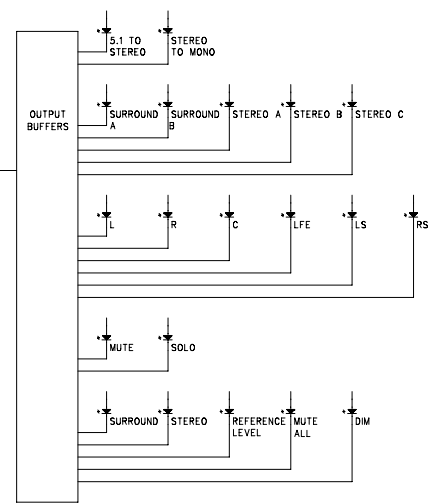
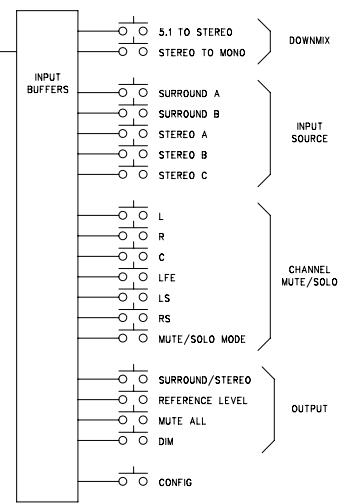
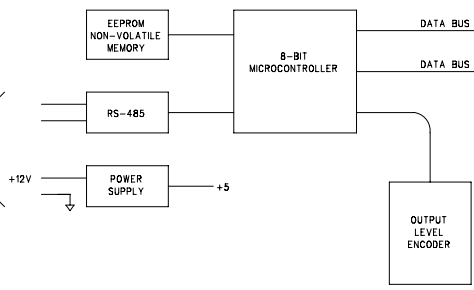

M77BD_A

| | | | |
|--|----------|------|-------|
| STUDIO TECHNOLOGIES, INC. | | | |
| MODEL 77 CONTROL CONSOLE BLOCK DIAGRAM | | | |
| DRAWING NO. | DATE | PAGE | |
| 31368 | 03/26/08 | 01 | OF 01 |